

PONUDBENI LIST**I. NARUČITELJ**

Naziv naručitelja	Zagrebački inovacijski centar
OIB	53921712112
Adresa	Avenija Dubrovnik 15, 10000 Zagreb
Odgovorna osoba Naručitelja	Frane Šesnić, direktor
Osoba za kontakt	Vini Vrsalović
Tel. / Fax	0959514393
E-mail	vini.vrsalovic@zicer.hr

II. PONUDITELJ

Naziv ponuditelja	DELIGHT D.O.O
OIB	80012427201
Sjedište	Radnička cesta 52, Zagreb
Adresa za dostavu pošte	Ivona.Loncar@delightoffice.com
Banka/broj računa	HR2924070001100528939EUR OTP Banka
Osoba za kontakt	Ivona Lončar
Tel. / Fax	+385 91 6189 941
E-mail	ivona.loncar@delightoffice.com

III. OSNOVNI PODACI NABAVE

Predmet nabave (CPV)	UREDSKI NAMJEŠTAJ ZA POSTOJEĆE UREDE STARTUP PODUZETNIKA CPV: 39130000-2
EBN (Evidencijski br. nabave)	24J0000023
Vrsta postupka i pravna osnova	Postupak jednostavne nabave sukladno PRAVILNIKU O POSTUPKU PROVOĐENJA JEDNOSTAVNE NABAVE U ZAGREBAČKOM INOVACIJSKOM CENTRU D.O.O.
Krajnji rok za dostavu ponude	3. rujna 2024. do 12,00 h
Način realizacije	Narudžbenica, rok 2 mjeseca

IV. PONUDA

Broj ponude	NBO-0000786
Datum ponude	03.09.2024
Cijena bez PDV-a	18000
Iznos PDV-a	4500
Cijena ponude s PDV-om	22500

Ime i prezime odgovorne osobe ponuditelja Ivona Lončar,
Senior Office Interior Consultant

Potpis: _____



M.P

PRILOG 2 TROŠKOVNIK I TEHNIČKE SPECIFIKACIJE

R.Br.	STAVKA	OPIS	KOLIČINA	JEDINIČNA MJERE	JEDINIČNA CIJENA BEZ PDV-A	UKUPNO
1	Uredski stolac	<p>Radni stolac sa približnim svojstvima ili jednakovrijedan :</p> <ul style="list-style-type: none"> - automatska regulacija otpora naslona prema masi korisnika sa tri vrste podešenja 1. Standardno naginjanje bazirano na masi korisnika 2. Naginjanje s dodatnim otporom bazirano na masi korisnika (veći otpor naslona) 3. Blokada naslona u vertikalnom položaju - sjedalica podesiva po dubini i visini - zaključavanje naslona u vertikalnom položaju - lumbalna potpora podesiva po visini u rasponu od 50 mm - rukonasloni podesivi po visini - rukonasloni izrađeni od poliamida ojačanog s 30% stakloplastike, prekriveni slojem poliuretanske pjene. - - peterokraka baza sa kotačima promjera 65mm - Mehanizam: - maksimalni nagib naslona od 17° - mogući raspon težine korisnika od 45 kg do 120 kg - pneumatski cilindar raspona 115 mm sjedećih visina od 395 mm - 510 mm od poda - podešavanje visine sjedalica na ručici sa desne strane stolice - podešavanje dubine sjedalice nomakom ručice koja se nalazi na desnoj donjoj strani sjedalice 	24	KOM	€ 441.57	€ 10.597.58
2	Ladica	<p>Pokretni ladičar dimenzija širina V510xŠ415xD500 mm s dvostruko okretnim kotačima promjera 37 mm, nosivosti 50 kg po kotačicu ili jednako vrijedan. Ladice obložene folijom sa bočnim stranama izrađenim od 12 mm MFC (melamina), dnom izrađenim od 4mm iverice duljine 450 mm, i minimalnom nosivosti 12 kg., i centralnim zaključavanjem. Korpus izrađen od 16mm MFC (melamina), sa 1 mm ABS rubom i mehanizmom protiv prevrtanja. Gornja ploha izrađena od 25 mm MFC (melamina) s 2 mm ABS rubom ili 16 mm MFC (melamina) s 1 mm ABS rubom. Uključene ručice</p>	24	KOM	€ 75.62	€ 1.814.88
3	Ormar	<p>Ormar sljedećih karakteristika ili jednakovrijedan - Dimenzija min: V1780xŠ1000xD400 mm, sa kliznim vratima na zaključavanje, s 6 polica od iverala s mogućnošću postavljanja na proizvoljnu visinu unutar ormara i 2 fiksne police, s predviđenim utorima za pričvršćivanje. Bočne stranice, gornji i donji paneli te stražnja ploča i police izrađeni od 18 mm MFC (melamina) s 1 mm ABS rubom. Nosivost polica min. 15kg. Ormar mora stajati na čeličnom soklu dimenzije i imati uključene adekvatne ručice.</p>	6	KOM	€ 294.51	€ 1.767.06
4	Uredski stol	<p>Kutni radni stol sljedećih karakteristika ili jednakovrijedan : - 4 metalne noge kvadratnog presjeka, dimenzija 40x40 mm s praškastim premazom i završnim capicama od plastike za mogućnost nivelacije po visini (+10mm). Noge stola pričvršćuju se zavarenom metalnom cijevi (podstrukturom) dimenzija 40x20 mm, metal je plastificiran u odabranoj boji nogu. Gornja ploha približnih dimenzija; - Duljina: 1600 - Širina: 1200 - U radnu ploču potrebno je moći implementirati otvor za kablove sa metalnim zatvaračem.</p>	24	KOM	€ 159.19	€ 3.820.56
5	Dostava i montaža	Dostava na adresu Avenija Dubrovnik 15, unos na 1.kat te montaža	1	KOMPLET	€ -	€ -
Ukupno bez PDV-a						€ 18.000.08
PDV						4.500.02 €
Ukupno sa PDV-om						22.500.11 €



U moj javnobilježnički ured pristupili su:-----

1. **ANTICA ARSOV, rod. Vučićević**, OIB 80497465440, iz Zagreba, Harambašićeva 12/1, rođena 19.11.1977., čiju sam istovjetnost utvrdila uvidom u osobnu iskaznicu broj 102325713, izdana od PU Zagrebačke, uvidom u Rodni list, Klasa: 223-02/2013-017/000001, izdao Gradski ured za opću upravu, Matični ured Maksimir, od 12.03.2013., Zagreb, te uvidom u Uvjerenje o prebivalištu, Broj:511-19-22/1-48757/2013, izdalo Ministarstvo unutarnjih poslova, PU Zagrebačka, od 18.03.2013, Zagreb, **kao prenositelj s jedne strane, te**-----
2. **ZORAN ARSOV**, iz Zagreba, Harambašićeva 12/1, OIB: 94559945553, rođen 15.08.1973., čiju sam istovjetnost utvrdila uvidom u osobnu iskaznicu broj 104859987, izdana od PU Zagrebačke, i----
3. **MIROSLAV TANAZEVIĆ**, iz Republike Srbije, Beograd, Koste Jovanovića 55, OIB: 05292010935, rođen 29.06.1978., čiju sam istovjetnost utvrdila uvidom u putovnicu broj PB0360400, izdala MZZ R Slovenije, i-----
4. **MARKO TANAZEVIĆ**, iz Republike Srbije, Beograd, Maršala Birjuzova 8, OIB: 59131467385, rođen 15.04.1980., čiju sam istovjetnost utvrdila uvidom u putovnicu broj PB0038427, izdala MZZ R Slovenije, i-----
5. **DELIGHT, cjelovita rješenja poslovnih prostora d.o.o.**, Republika Slovenija, Trzin, Kidričeva ulica 13 D, OIB: 61850017952, Matični broj: 6257798000, upisano pri Okružnom sudu u Kranju, zastupano po direktoru Miroslavu Tanazeviću, s ovlaštenjem da zastupa društvo samostalno, što sam utvrdila uvidom u Ovjereni prijevod sa slovenskog jezika Stalnog sudskog tumača za slovenski jezik, Ratka Kovačića, iz Sračinca, pod brojem OV-89/2013, od 11.03.2013. Redovitog izvotka iz sudskog/poslovnog registra od 11.ožujka 2013., **kao stjecatelji, s druge strane,**-----

te su predamnom, javnim bilježnikom Mirjanom Trkman Pajić, iz Zagreba, Škrlečeva 39, izjavili da žele sklopiti Ugovor o prijenosu poslovnih udjela.-----

Svjedoci akta nisu nazočni budući ih Zakon o javnom bilježništvu ne propisuje, a stranke i javni bilježnik ih nisu tražili.-----

Budući da stranke razumiju hrvatski jezik, sudski tumač nije nazočan.-----

Utvrdila sam da su stranke sposobne i ovlaštene za poduzimanje ovog pravnog posla, objasnila sam im smisao i posljedice posla i uvjerala se u njihovu pravu i ozbiljnu volju, te sam u njihovoj nazočnosti sastavila slijedeći:-----

UGOVOR O PRIJENOSU POSLOVNIH UDJELA

Članak I

Ugovorne strane suglasno utvrđuju da je, prenositelj Antica Arsov, jedini član trgovačkog društva A DVA DESIGN d.o.o. za grafički dizajn, sa sjedištem u Zagrebu, (Grad Zagreb) Jordanovac 1, upisnog u registar Trgovačkog suda u Zagrebu pod brojem MBS:080487057, OIB 80012427201.-----

Temeljni kapital Društva iznosi 20.000,00 (dvadesettisuća) kuna i sastoji se od četiri poslovna udjela. -----

Prenositelju pripadaju četiri poslovna udjela i to: I poslovni udjel u nominalnom iznosu od 5.900,00 (pettisućadevetsto) kuna, koji se vodi u Knjizi poslovnih udjela pod rednim brojem 1 (jedan), II poslovni udjel u nominalnom iznosu od 6.900,00 (šesttisućadevetsto) kuna, koji se vodi u Knjizi poslovnih udjela pod rednim brojem 2 (dva), III poslovni udjel u nominalnom iznosu od 6.900,00 (šesttisućadevetsto) kuna, koji se vodi u Knjizi poslovnih udjela pod rednim brojem 3 (tri), IV poslovni udjel u nominalnom iznosu od 300,00 (tristo) kuna koji se vodi u Knjizi poslovnih udjela pod rednim brojem 4 (četiri), uplaćeni u društvo u cijelosti, u novcu.--

Članak II

Ovim Ugovorom regulira se prijenos poslovnih udjela opisanih u članku I, kao i svih prava i obveza koje iz istog proizlaze za ugovorne strane.-----

Članak III

Antica Arsov, prenositelj, prenosi I (prvi) poslovni udjel nominalnog iznosa 5.900,00 (pettisućadevetsto) kuna na stjecatelja, Zorana Arsova, bez naknade, koji prihvaća ustupljeni poslovni udjel, kao i sva vlasnička i upravljačka prava i obveze koje iz njega proizlaze.-----

Antica Arsov, prenositelj, prenosi II (drugi) poslovni udjel nominalnog iznosa 6.900,00 (šesttisućadevetsto) kuna na stjecatelja, Miroslava Tanazevića, bez naknade, koji prihvaća ustupljeni poslovni udjel, kao i sva vlasnička i upravljačka prava i obveze koje iz njega proizlaze.-----

Antica Arsov, prenositelj, prenosi III (treći) poslovni udjel nominalnog iznosa 6.900,00 (šesttisućadevetsto) kuna na stjecatelja, Marka Tanazevića, bez naknade, koji prihvaća ustupljeni poslovni udjel, kao i sva vlasnička i upravljačka prava i obveze koje iz njega proizlaze.-----

Antica Arsov, prenositelj, prenosi IV (četvrti) poslovni udjel nominalnog iznosa 300,00 (tristo) kuna na stjecatelja, DELIGHT, cjelovita rješenja poslovnih prostora, d.o.o., bez naknade, koji prihvaća ustupljeni poslovni udjel, kao i sva vlasnička i upravljačka prava i obveze koje iz njega proizlaze.-----

Članak IV

Nakon izvršenog prijenosa poslovnih udjela, prenositelj prestaje biti član društva.-----

Članak V

Prenositelj jamči da njegovi poslovni udjeli u društvu nisu opterećeni pravima trećih i da s njima mogu slobodno raspolagati.---

Članak VI

Prenositelj dozvoljava stjecateljima da temeljem ovog Ugovora bez svakog daljnjeg pitanja i odobrenja izvrše upis svojih poslovnih udjela na svoje ime u Knjizi poslovnih udjela, sudskom registru Trgovačkog suda i drugim javnim knjigama. -----

Članak VII

Temeljem ovog ugovora uprava društva će, sukladno odredbama čl. 410. Zakona o trgovačkim društvima, izvjestiti Trgovački sud u Zagrebu o nastalim promjenama članova društva i poslovnih udjela.-----

Članak VIII

U znak suglasnosti da primaju prava i obveze iz ovog Ugovora koji je sastavljen u izvorniku i 6 (šest) istovjetnih otpravaka, koji je strankama pročitani i protumačeni, ugovorne strane isti u prisutnosti javnog bilježnika potpisuju.-----

U Zagrebu, 19.ožujka 2013.-----
(devetnaestogožujkadvijetisućetrinaeste)-----
prenositelj: stjecatelji:

Antica Arsov, v.r.

Zoran Arsov, v.r.

Miroslav Tanazević, v.r.

Marko Tanazević, v.r.

M.P. DELIGHT, cjelovita rješenja
poslovnih prostora d.o.o., v.r.

Potvrđujem da sam ugovornim stranama ovaj Ugovor o prijenosu poslovnih udjela pročitala i protumačila, nakon čega stranke izjavljuju da su Ugovor razumjele u potpunosti i da on predstavlja njihovu pravu i ozbiljnu volju, te ga vlastoručno potpisuju u mojoj nazočnosti.-----

Strankama izdano 5 (pet) istovjetnih otpravaka, te uz njihovu suglasnost 1 (jedan) otpravak za Trgovački sud.-----

Javnobilježnička pristojba naplaćena temeljem TB 1 i 3 ZJP u iznosu od
60,00 (šezdeset)kuna.-----

Javnobilježnička nagrada naplaćena temeljem čl. 12.st.5. PPJBT u iznosu od
1.000,00 (tisuću) kuna plus 25% PDV-a.-----

M.P. Javni bilježnik
Mirjana Trkman Pajić, v.r.

Ja, **JAVNI BILJEŽNIK MIRJANA TRKMAN PAJIĆ** iz Zagreba, Škrlčeva 39 potvrđujem da sam ovaj **OTPRAVAK** usporedila sa izvornikom koji se nalazi u mojim spisima i utvrdila da je doslovno podudaran s izvornikom.-----

Ovo je 4 (četvrti) otpravak običan - ovjeren - potpun - u izvodu, kojem je priloženo / prijepisa priloga javnobilježničkog akta.-----

Ovaj je otpravak sastavljen za

Miroslav Tanazević

Ovaj otpravak u pravnom prometu u cijelosti zamjenjuje izvornik.-----

Javnobilježnička pristojba po tar. br.-- ZJP u iznosu od --- kn naplaćena i poništena na primjerku koji ostaje za arhiv.-----

Oslobođeno od plaćanja javnobilježničke pristojbe na temelju čl. --- ZJP. Javnobilježnička nagrada zaračunata u iznosu od ---- kn, a trošak po čl. -- PPJBT u iznosu od -- kn.-----

Broj : **OU-30/13-1**

U Zagrebu, 19. ožujka 2013.



JAVNI BILJEŽNIK
Mirjana Trkman Pajić

Za javnog bilježnika
Prisjednik
Jana Pajić

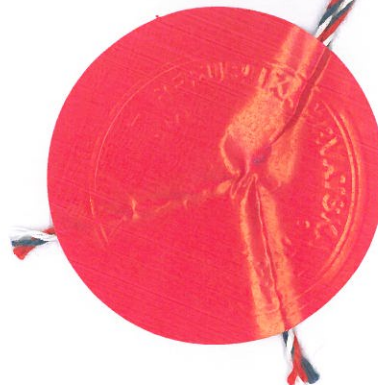



REPUBLIKA HRVATSKA
JAVNI BILJEŽNIK
MIRJANA TRKMAN PAJIĆ
Škrlečeva 39, ZAGREB

OTPRAVAK
OU-30/13-2

U moj javnobilježnički ured pristupili su:-----

1. **ZORAN ARSOV**, iz Zagreba, Harambašićeva 12/1, OIB: 94559945553, rođen 15.08.1973., čiju sam istovjetnost utvrdila uvidom u osobnu iskaznicu broj 104859987, izdana od PU Zagrebačke,-----
2. **MIROSLAV TANAZEVIĆ**, iz Republike Srbije, Beograd, Koste Jovanovića 55, OIB: 05292010935, rođen 29.06.1978., čiju sam istovjetnost utvrdila uvidom u putovnicu broj PB0360400, izdala MZZ R Slovenije,-----
3. **MARKO TANAZEVIĆ**, iz Republike Srbije, Beograd, Maršala Birjuzova 8, OIB: 59131467385, rođen 15.04.1980., čiju sam istovjetnost utvrdila uvidom u putovnicu broj PB0038427, izdala MZZ R Slovenije,-----
4. **DELIGHT**, cjelovita rješenja poslovnih prostora d.o.o., Republika Slovenija, Trzin, Kidričeva ulica 13 D, OIB: 61850017952, Matični broj: 6257798000, upisano pri Okružnom sudu u Kranju, zastupano po direktoru Miroslavu Tanazeviću, s ovlaštenjem da zastupa društvo samostalno, što sam utvrdila uvidom u Redoviti izvadak iz sudskog/poslovnog registra, izdanog od AJPES-Agencija Republika Slovenije za javnopravne evidencije i usluge, Ispostava Ljubljana, od 11.ožujka 2013., ovjerenog prijevoda sa slovenskog jezika stalnog sudskog tumača za slovenski jezik, Ratka Kovačića, iz Sračinca, pod brojem OV-89/2013, od 11.03.2013.-----
kao članovi društva **A DVA DESIGN d.o.o.**, Zagreb, (Grad Zagreb) Jordanovac 1, upisnog u registar Trgovačkog suda u Zagrebu pod brojem MBS:080487057, OIB 80012427201, koji ujedno čine skupštinu društva, sa zastupljenih 100% temeljnog kapitala, a koji su to postali na temelju Ugovora o prijenosu poslovnih udjela u društvu **A DVA DESIGN d.o.o.**, sastavljenom u ovom javnobilježničkom uredu u obliku javnobilježničkog akta pod poslovnim brojem OU-30/13-1, dana 19.03.2013. te su isti predamnom, Mirjanom Trkman Pajić, javnim bilježnikom iz Zagreba, Škrlečeva 39, izjavili da, kao članovi društva, koji ujedno čine i skupštinu Društva, žele donijeti:-----

1. Odluku o promjeni tvrtke
2. Odluku o promjeni predmeta poslovanja
3. Odluku o opozivu i imenovanju direktora
4. Odluku o izmjeni Izjave o osnivanju društva s ograničenom odgovornošću od 22.03.2004. u novi akt društva **DRUŠTVENI UGOVOR DELIGHT d.o.o.**

Temeljni kapital društva iznosi 20.000,00 (dvadesettisuća) kuna i unesen je u društvo u cijelosti u novcu.-----

Svjedoci akta nisu nazočni budući ih Zakon o javnom bilježništvu ne propisuje, a stranke i javni bilježnik ih nisu tražili.-----

Budući da stranke razumiju hrvatski jezik, sudski tumač nije nazočan.---

Utvrdila sam da su stranke sposobne i ovlaštene za poduzimanje ovog pravnog posla, objasnila sam im smisao i posljedice posla i uvjerala se u njihovu pravu i ozbiljnu volju, te sam u njihovoj nazočnosti sastavila

slijedeće:-----

1. Odluka o promjeni tvrtke

I

Mijenja se tvrtka društva na način da izmijenjena glasi:-----
Tvrtka: DELIGHT društvo s ograničenom odgovornošću za poslovno savjetovanje---
Skraćena tvrtka: DELIGHT d.o.o.-----

2. Odluka o promjeni predmeta poslovanja

I

Mijenja se premet poslovanja na način da se briše djelatnost:-----
* projektiranje, građenje i nadzor nad građenjem;-----
a upisuju se slijedeće djelatnosti:-----
* montaža, ugradnja i popravak namještaja;
* prijevoz za vlastite potrebe;
* skladištenje robe;
* stručni poslovi prostornog uređenja;
* projektiranje, građenje, uporaba i uklanjanje građevina;
* nadzor nad gradnjom;
* poslovi upravljanja nekretninom i održavanja nekretnine;
* djelatnost informacijskog društva;
* iznajmljivanje motornih vozila;
* turističke usluge u nautičnom turizmu.-----

3. Odluka o opozivu i imenovanju direktora

I

Opoziva se dosadašnji direktor trgovačkog društva A DVA DESIGN d.o.o. s
danom 19.03.2013.:-----
Antica Vučićević, OIB 80497465440, Zagreb, Ivekovićeva 21.-----

II

Za direktora društva, s ovlaštenjem da zastupa društvo pojedinačno i
samostalno, imenuje se s danom 19.03.2013.:-----
Zoran Arsov, Zagreb, Harambašićeva 12/1, OIB: 94559945553.-----

4. Odluka o izmjeni

**Izjave o osnivanju društva s ograničenom odgovornošću od
22.03.2004.**

**u novi akt društva pod nazivom
DRUŠTVENI UGOVOR DELIGHT d.o.o. od 19.03.2013.**

I

Zoran Arsov, Miroslav Tanazević, Marko Tanazević i DELIGHT, cjelovita
rješenja poslovnih prostora d.o.o., članovi društva, KOJI DRŽE 100% TEMELJNOG
KAPITALA DRUŠTVA, TE UJEDNO ČINE SKUPŠTINU DRUŠTVA, dana 19.03.2013.
(devetnaestogozujkadvijetisućetrinaeste) mijenjaju Izjavu o osnivanju društva
s ograničenom odgovornošću od 22.03.2004. u cijelosti u novi akt društva
Društveni ugovor koji glasi:-----

DRUŠTVENI UGOVOR DELIGHT d.o.o.

Tvrtka Društva-----

Članak 1.

Tvrtka društva glasi: DELIGHT društvo s ograničenom odgovornošću za poslovne usluge.-----

Skraćena tvrtka društva glasi: DELIGHT d.o.o.-----

Sjedište i poslovna adresa Društva-----

Članak 2.

Sjedište društva je : Zagreb.-----

Poslovna adresa određuje se posebnom odlukom.-----

Uprava Društva ovlaštena je samostalno, bez prethodne suglasnosti ili posebne odluke članova Društva, shodno potrebama poslovanja Društva, promijeniti poslovnu adresu Društva unutar mjesta sjedišta, bez obveze mijenjanja temeljnog akta Društva.-----

Predmet poslovanja Društva-----

Članak 3.

Predmet poslovanja društva sastoji se od slijedećih djelatnosti:-----

- * Djelatnost pripreme za tiskanje;
- * Pomoćne djelatnosti povezane s tiskanjem;
- * Umnožavanje snimljenih zapisa;
- * Računalne i srodne djelatnosti;
- * Istraživanje tržišta i ispitivanje javnog mnijenja;
- * Savjetovanje u vezi s poslovanjem i upravljanjem;
- * Promidžba (reklama i propaganda);
- * Fotografske djelatnosti;
- * Usluge grafičkog i kompjuterskog oblikovanja (design);
- * Kupnja i prodaja robe;
- * Obavljanje posredovanja u domaćem i inozemnom tržištu;
- * Snimanje i presnimavanje video materijala;
- * Tonska obrada muzičkog materijala;
- * Zastupanje stranih tvrtki;
- * Tiskanje časopisa i drugih periodičnih časopisa, knjiga i plakata, igraćih karata, reklamnih kataloga, prospekata i drugih tiskanih oglasa, djelovodnika, albuma, dnevnika, kalendara, poslovnih obrazaca i drugih tiskanih oglasa i komercijalnih publikacija;
- * montaža, ugradnja i popravak namještaja;
- * prijevoz za vlastite potrebe;
- * skladištenje robe;
- * stručni poslovi prostornog uređenja;
- * projektiranje, građenje, uporaba i uklanjanje građevina;
- * nadzor nad gradnjom;
- * poslovi upravljanja nekretninom i održavanja nekretnine;
- * djelatnost informacijskog društva;
- * iznajmljivanje motornih vozila;
- * turističke usluge u nautičnom turizmu.-----

Društvo je ovlašteno obavljati sve poslove i poduzimati sve mjere koje služe predmetu poslovanja Društva.-----

Uprava Društva ovlaštena je samostalno, bez prethodne suglasnosti ili posebne odluke članova Društva, shodno potrebama poslovanja Društva, osnivati podružnice Društva.-----

Društvo može osnivati druga trgovačka društva ili stjecati udjele u

takvim društvima. -----

Temeljni kapital Društva-----

Članak 5.

Temeljni kapital društva iznosi 20.000,00 (dvadesettisuća) kuna, a sastoji se od četiri poslovna udjela, unesena u društvo u cjelosti u novcu.---

Član Društva Zoran Arsov u društvu drži jedan poslovni udjel u nominalnom iznosu od 5.900,00 (pettisućadevetsto) kuna koji se vodi u Knjizi poslovnih udjela pod rednim brojem 1 (jedan).-----

Član Društva Miroslav Tanazević u društvu drži jedan poslovni udjel u nominalnom iznosu od 6.900,00 (šesttisućadevetsto)kuna, koji se vodi u Knjizi poslovnih udjela pod rednim brojem 2 (dva).-----

Član Društva Marko Tanazević u društvu drži jedan poslovni udjel u nominalnom iznosu od 6.900,00 (šesttisućadevetsto) kuna koji se vodi u Knjizi poslovnih udjela pod rednim brojem 3 (tri).-----

Član Društva DELIGHT cjelovita rješenja poslovnih prostora d.o.o., u društvu drži jedan poslovni udjel u nominalnom iznosu od 300,00 (tristo) kuna koji se vodi u Knjizi poslovnih udjela pod rednim brojem 4(četiri).-----

Zbroj nominalnih iznosa odgovora iznosu temeljnog kapitala društva.-----

Raspologanje poslovnim udjelom-----

Članak 6.

Članovi društva preuzeli su poslovne udjele u cijelosti.-----

Poslovni udjeli u Društvu mogu se dijeliti i prenositi osobama koji nisu članovi društva samo uz suglasnost svih članova Društva.-----

Uzima se da su članovi Društva dali suglasnost za prijenos, ako u roku od 15 (petnaest) dana od primitka pisanog zahtjeva za davanje suglasnosti nisu obavijestili tražitelja o uskrati tražene suglasnosti.-----

Pravo prvokupa-----

Članak 7.

Članovi Društva imaju pravo prvokupa poslovnog udjela ili dijela poslovnog udjela kojim član namjerava raspolagati i to razmjerno s veličinom poslovnog udjela u njihovom vlasništvu u trenutku otkupa ponuđenog poslovnog udjela ili dijela poslovnog udjela.-----

Član Društva koji želi iskoristiti pravo prvokupa, mora u roku od 15 dana od dana primitka obavijesti uprave Društva, o svojoj namjeri da iskoristi pravo prvokupa pismeno obavijestiti upravu Društva i člana koji želi raspolagati svojim poslovnim udjelom ili dijelom poslovnog udjela. Ne uputi li član Društva nikakvu obavijest u roku od 15 dana od kada je primio obavijest uprave Društva, gubi pravo prvokupa.-----

Organi društva-----

Članak 8.

Organi društva jesu uprava i skupština.-----

Članak 9.

Zastupanje i poslovanje vodi uprava društva.-----

Uprava se sastoji od jednog do tri člana - direktora, koje imenuje skupština društva većinom glasova.-----

Visinu naknade za rad uprave određuje skupština društva.-----

Članak 10.

Uprava vodi poslove društva na vlastitu odgovornost.-----

Član uprave - direktor zastupa društvo u pravnim poslovima sa trećim osobama i

u vanjsko trgovinskim poslovima pojedinačno i samostalno.-----

Članak 11.

Uprava odgovara za izradu financijskih izvješća društva koje je obvezna dostaviti ovlaštenim organima u rokovima propisanim zakonom.-----

Članak 12.

Poslove društva uprava je dužna voditi s pozornošću urednog i savjesnog gospodarstvenika te čuvati poslovnu tajnu društva.-----

Članak 13.

Skupštinu saziva uprava društva najmanje jednom godišnje, a uvijek kad to zahtjevaju interesi društva.-----

Skupština može valjano odlučivati ako su na njoj prisutni članovi društva ili njihovi zastupnici koje predstavljaju najmanje 75% temeljnog kapitala društva.-----

Skupština donosi odluke 3/4 (tročetvrtinskom) većinom glasova prisutnih članova.-----

Skupština društva odlučuje o slijedećim pitanjima:-----

- Financijskim izvješćima društva, upotrebi ostvarene dobiti i pokrivanju gubitaka-----
- Imenovanju i opozivu članova uprave,-----
- Podjeli i povlačenju poslovnih udjela,-----
- Mjerama za ispitivanje i nadzor nad vođenjem poslova,-----
- Izmjeni društvenog ugovora,-----

Prokura-----

Članak 14.

Društvo može imenovati jednog ili više prokurista koji mogu biti ovlašteni za pojedinačno ili kolektivno zastupanje.-----

Prokura se daje u pismenom obliku i nije prenosiva na drugu osobu.-----

Članak 15.

Prokurist može sklapati sve ugovore i poduzimati sve pravne radnje u ime i za račun trgovačkog društva, te zastupati društvo u postupcima pred upravnim i drugim državnim tijelima i sudovima.-----

Prokurist ne može bez posebnog ovlaštenja otuđiti niti opteretiti nekretnine trgovačkog društva i ne može davati izjave ni poduzimati pravne radnje kojima se započinje stečajni postupak ili drugi postupak koji dovodi do prestanka društva.-----

Prestanak društva-----

Članak 16.

Društvo je osnovano na neodređeno vrijeme.-----

Društvo može prestati odlukom članova, pravomoćnom odlukom suda, otvaranjem stečajnog postupka, ukidanjem društva i pripajanjem drugom društvu odnosno spajanjem s drugim društvom.-----

Članak 17.

Odluka o prestanku društva se donosi u obliku javnobilježničke isprave i mora se prijaviti sudu radi upisa u Trgovački registar.-----

Članak 18.

Glasiilo društva je službeno glasiilo Republike Hrvatske, a izdaju ga Narodne novine.-----

Članak 19.

U znak pristanka na prava i obveze iz ovog ugovora članovi isti potpisuju.-----

Ovaj akt sadrži pravu volju članova društva, te ga isti u znak prihvaćanja svih prava i obveza u njemu stipuliranih, vlastoručno potpisuju, te istovremeno izjavljuju da im je akt bio pročitao i protumačen i da to odgovara njihovoj pravnoj i ozbiljnoj volji. -----

Pri sačinjenju ovog akta izdani su otpravci strankama, društvu, te uz njihovu suglasnost i za Trgovački sud.-----

Naplaćena nagrada po čl. 12.st.5. PPJBT u iznosu od 1.000,00 kn plus 25% PDV-a.-----

Plaćena javnobilježnička pristojba po Tbr. 1. i 3. ZJP u iznosu od 60,00 Kn.-----

U Zagrebu, 19.03.2013. (devetnaestogozujkadvijetisućetrinaeste)-----

Članovi društva
koji čine skupštinu društva:

1. ZORAN ARSOV, v.r.
2. MIROSLAV TANAZEVIĆ, v.r.
3. MARKO TANAZEVIĆ, v.r.
4. M.P. DELIGHT, cjelovita rješenja
poslovnih prostora d.o.o.,
zastupano po direktoru
Miroslavu Tanazeviću, v.r.

M.P. JAVNI BILJEŽNIK
Mirjana Trkman Pajić, v.r.

P O T V R D A

Potvrđujem da su odredbe Izjave o osnivanju trgovačkog društva A DVA DISEGN d.o.o., Zagreb, od 22.03.2004., upisano u registru Trgovačkog suda u Zagrebu, MBS:080487057, OIB:80012427201, odlukom članova društva u ovom aktu u potpunosti izmjenjene i preimenovane u Društveni ugovor DELIGHT d.o.o. i u potpunosti odgovaraju gornjem tekstu Društvenog ugovora, koji je jedini važeći.

M.P. JAVNI BILJEŽNIK
Mirjana Trkman Pajić, v.r.

Ja, **JAVNI BILJEŽNIK MIRJANA TRKMAN PAJIĆ** iz Zagreba, Škrlčeva 39 potvrđujem da sam ovaj **OTPRAVAK** usporedila sa izvornikom koji se nalazi u mojim spisima i utvrdila da je doslovno podudaran s izvornikom.-----

Ovo je 4 (četvrti) otpравak običan - ovjeren - potpun - u izvodu, kojem je priloženo / prijepisa priloga javnobilježničkog akta.-----

Ovaj je otpравak sastavljen za

Miroslav Tauarević

Ovaj otpравak u pravnom prometu u cijelosti zamjenjuje izvornik.-----

Javnobilježnička pristojba po tar. br.-- ZJP u iznosu od --- kn naplaćena i poništena na primjerku koji ostaje za arhiv.-----

Oslobođeno od plaćanja javnobilježničke pristojbe na temelju čl. --- ZJP. Javnobilježnička nagrada zaračunata u iznosu od ---- kn, a trošak po čl. -- PPJBT u iznosu od -- kn.-----

Broj : **OU-30/13-2**

U Zagrebu, 19. ožujka 2013.



JAVNI BILJEŽNIK
Mirjana Trkman Pajić

(Handwritten signature)
za javnog bilježnika
Prisjednik
Jana Pajić





IZVADAK IZ SUDSKOG REGISTRA

SUBJEKT UPISA

MBS:

080487057

OIB:

80012427201

EUID:

HRSR.080487057

TVRTKA:

2 DELIGHT društvo s ograničenom odgovornošću za poslovno savjetovanje

2 DELIGHT d.o.o.

SJEDIŠTE/ADRESA:

3 Zagreb (Grad Zagreb)
Radnička cesta 52

PRAVNI OBLIK:

1 društvo s ograničenom odgovornošću

PREDMET POSLOVANJA:

- 1 22.24 - Djelatnosti pripreme za tiskanje
- 1 22.25 - Pomoćne djelatnosti povezane s tiskanjem
- 1 22.3 - Umnožavanje snimljenih zapisa
- 1 72 - Računalne i srodne djelatnosti
- 1 74.13 - Istraživanje tržišta i ispitivanje javnoga mnijenja
- 1 74.14 - Savjetovanje u vezi s poslovanjem i upravljanjem
- 1 74.4 - Promidžba (reklama i propaganda)
- 1 74.81 - Fotografske djelatnosti
- 1 * - usluge grafičkog i kompjuterskog oblikovanja (design)
- 1 * - kupnja i prodaja robe
- 1 * - obavljanje posredovanja u domaćem i inozemnom tržištu
- 1 * - snimanje i presnimavanje video materijala
- 1 * - tonska obrada muzičkog materijala
- 1 * - zastupanje stranih tvrtki
- 1 * - tiskanje časopisa i drugih periodičnih časopisa, knjiga i plakata, igračih karata, reklamnih kataloga, prospekata i drugih tiskanih oglasa, djelovodnika, albuma, dnevnika, kalendara, poslovnih obrazaca i drugih tiskanih oglasa i komercijalnih publikaci
- 2 * - montaža, ugradnja i popravak namještaja
- 2 * - prijevoz za vlastite potrebe
- 2 * - skladištenje robe
- 2 * - stručni poslovi prostornog uređenja
- 2 * - projektiranje, građenje, uporaba i uklanjanje građevina
- 2 * - nadzor nad gradnjom
- 2 * - poslovi upravljanja nekretninom i održavanje



IZVADAK IZ SUDSKOG REGISTRA

SUBJEKT UPISA

PREDMET POSLOVANJA:

- nekretnina
- 2 * - djelatnost informacijskog društva
- 2 * - iznajmljivanje motornih vozila
- 2 * - turističke usluge u nautičkom turizmu

OSNIVAČI/ČLANOVI DRUŠTVA:

- 4 ZORAN ARSOV, OIB: 94559945553
Zagreb, Ulica Augusta Harambašića 12/1
- 2 - član društva
- 5 DELIGHT HOLDING DOO BEOGRAD, Srbija, Broj iz registra: 21740560,
Naziv registra: Agencija za gospodarske registre, Nadležno tijelo:
Agencija za gospodarske registre, OIB: 06746886087
Srbija, NOVI BEOGRAD, OMLADINSKIH BRIGADA 90V
- 5 - član društva

OSOBE OVLAŠTENE ZA ZASTUPANJE:

- 4 ZORAN ARSOV, OIB: 94559945553
Zagreb, Ulica Augusta Harambašića 12/1
- 2 - direktor
- 2 - zastupa pojedinačno i samostalno, odlukom članova društva
imenovan je za direktora društva s danom 19.03.2013. godine

TEMELJNI KAPITAL:

- 1 20.000,00 kuna / 2.654,46 euro (fiksni tečaj konverzije 7.53450)

Napomena:

Iznos temeljnog kapitala informativno je prikazan u euru i ne utječe na prava i obveze društva niti članova društva.
Društva su u obvezi temeljni kapital uskladiti sukladno Zakonu o izmjenama Zakona o trgovačkim društvima ("Narodne novine" broj 114/22.).

PRAVNI ODNOSI:

Osnivački akt:

- 1 Izjava o osnivanju od 22.03.2004.god.
- 2 Odlukom članova društva od 19.03.2013. godine Izjava o osnivanju od 22.03.2004. godine u cijelosti je zamijenjena novim aktom pod nazivom Društveni ugovor DELIGHT d.o.o.
Društveni ugovor od 19.03.2013. godine dostavljen je u zbirku isprava.
- 6 Odlukom članova društva od 12.01.2022. godine izmijenjen je u cijelosti Društveni ugovor od 19.03.2013. godine i u potpunom tekstu dostavljen u zbirku isprava.

FINANCIJSKA IZVJEŠĆA:



IZVADAK IZ SUDSKOG REGISTRA

SUBJEKT UPISA

FINANCIJSKA IZVJEŠĆA:

	Predano	God.	Za razdoblje	Vrsta izvještaja
eu	15.05.23	2022	01.01.22 - 31.12.22	GFI-POD izvještaj

Upise u glavnu knjigu proveli su:

RBU	Tt	Datum	Naziv suda
0001	Tt-04/3369-2	19.04.2004	Trgovački sud u Zagrebu
0002	Tt-13/7327-2	27.03.2013	Trgovački sud u Zagrebu
0003	Tt-13/12376-2	29.05.2013	Trgovački sud u Zagrebu
0004	Tt-21/32335-1	15.07.2021	Trgovački sud u Zagrebu
0005	Tt-22/1492-2	28.01.2022	Trgovački sud u Zagrebu
0006	Tt-22/1493-2	18.02.2022	Trgovački sud u Zagrebu
eu	/	31.03.2009	elektronički upis
eu	/	25.03.2010	elektronički upis
eu	/	30.03.2012	elektronički upis
eu	/	08.04.2013	elektronički upis
eu	/	19.03.2014	elektronički upis
eu	/	30.06.2015	elektronički upis
eu	/	03.06.2016	elektronički upis
eu	/	05.06.2017	elektronički upis
eu	/	06.06.2018	elektronički upis
eu	/	29.05.2019	elektronički upis
eu	/	29.06.2020	elektronički upis
eu	/	02.06.2021	elektronički upis
eu	/	13.05.2022	elektronički upis
eu	/	15.05.2023	elektronički upis

Sukladno Uredbi o tarifi sudskih pristojbi (NN br. 37/2023)
Tar. br. 28. ne plaća se pristojba za izdavanje aktivnog i/ili
povijesnog izvotka iz sudskog registra.



IZVADAK IZ SUDSKOG REGISTRA

SUBJEKT UPISA



Ova isprava je u digitalnom obliku elektronički potpisana certifikatom:
CN=sudreg, L=ZAGREB,
O=MINISTARSTVO PRAVOSUĐA I UPRAVE HR72910430276, C=HR

Broj zapisa: 00UB6-bleF1-ixUNB-bcQTy-j47Fk
Kontrolni broj: K4DCg-z7qA1-r7C3W-3DSqp

Skeniranjem ovog QR koda možete provjeriti točnost podataka.

Isto možete učiniti i na web stranici

http://sudreg.pravosudje.hr/registar/kontrola_izvornika/ unosom gore navedenog broja zapisa i kontrolnog broja dokumenta.

U oba slučaja sustav će prikazati izvornik ovog dokumenta. Ukoliko je ovaj dokument identičan prikazanom izvorniku u digitalnom obliku, Ministarstvo pravosuđa i uprave potvrđuje točnost isprave i stanje podataka u trenutku izrade izvotka.

Provjera točnosti podataka može se izvršiti u roku tri mjeseca od izdavanja isprave.



REPUBLIKA HRVATSKA
MINISTARSTVO FINANCIJA
POREZNA UPRAVA
PODRUČNI URED ZAGREB
ISPOSTAVA TRNJE

Elektronički zapis



KLASA: 034-04/24-10/11503
URBROJ: 513-07-01-11-24-2

ZAGREB, DRAGUTINA ALBRECHTA 42, 30. kolovoza 2024.

Temeljem članka 11. točke 8. Zakona o Poreznoj upravi (Narodne novine, broj 115/16 i 98/19), članka 159. Zakona o općem upravnom postupku (Narodne novine, broj 47/09 i 110/21) i članka 4. Općeg poreznog zakona (Narodne novine, broj 115/16, 106/18, 121/19, 32/20, 42/20 i 114/22), na zahtjev stranke izdaje se

P O T V R D A

kojom se potvrđuje da

DELIGHT D.O.O.

(Ime i prezime ili naziv)

Radnička cesta 52, 10000 Zagreb, Zagreb

(Adresa)



80012427201

(OIB)

na dan 30.08.2024., nema duga po osnovi javnih davanja o kojima službenu evidenciju vodi Porezna uprava.

Ova potvrda se izdaje u svrhu sudjelovanja u postupku javne nabave.

Sukladno Napomeni u Tar. br. 4. Tarife upravnih pristojbi iz Priloga I. Uredbe o Tarifi upravnih pristojbi (Narodne novine, broj 156/22) upravna pristojba se ne plaća pred tijelima državne uprave.

 REPUBLIKA HRVATSKA MINISTARSTVO FINANCIJA POREZNA UPRAVA	Vrijeme izdavanja:	30.08.2024. 10:24:09
	Izdavatelj certifikata:	CN=Fina RDC 2020, O=Financijska agencija, C=HR
	Naziv certifikata:	SERIALNUMBER=18683136487.275.37, CN=MINISTARSTVO FINANCIJA POREZNA UPRAVA, L=ZAGREB, OU=POREZNA UPRAVA, OID.2.5.4.97=VATHR-18683136487, O=REPUBLIKA HRVATSKA MINISTARSTVO FINANCIJA, C=HR
	Algoritam potpisa:	SHA256withRSA
	Broj zapisa:	55B18EA20008
	Kontrolni broj:	2429
	Na internet adresi https://porezna.gov.hr/dokumenti/provjera.html možete provjeriti točnost podataka navedenih u ovom elektroničkom zapisu. Upisivanjem broja zapisa i kontrolnog broja ili skeniranjem QR koda, sustav će pokazati izvornik ove isprave. Ukoliko je ova isprava identična prikazanom izvorniku u digitalnom obliku, Ministarstvo financija, Porezna uprava, potvrđuje točnost isprave i stanja podataka u trenutku izrade isprave.	



ZIC - Zagrebacki inovativni centar d.o.o
 .
Avenija Dubrovnik 15
OIB: 53921712112
10000 ZAGREB
HR

Quotation
Type of order

NBO-0000786
 Standard

Your contact :
 Date



Delight
09/03/2024

Line	Short name	Unit Sale	Quantity	Price
1	CHAIR-SERIES 1, WEIGHT-ACTIVATED MECH TASK CHAIR, MESH BACK  Back Finish Group Back Finish Back Color Scheme Membrane&Lumbar Support Finish Seat Finish Group Seat Finish (Upholstery Col.) Frame Finish Arm Type Cylinder Type Base Type Base Finish Castors or Glides Type Sewn Upholstery Type Shock absorber Seat Angle Adjustment Headrest Coat hanger Method of delivery Model number : 435A00			
	3DMICRKNIT - 3D Microknit 5T21 - T 60999 3D Micro Knit NONCONTR - Non-Contrasting Outer Back 6205 - Black 5E - Era 5ER9 - CSE14 6205 - Black HWPDARM - Height,Width,Pivot,Depth Arm STDRNG - Standard Range PLASBASE - Plastic base 6205 - Black SOFTCST - Soft Casters SEWN - Sewn 00 - Without 00 - Without 01 - With SC - Without 04 - Chair knock down			
		519.49	24 - 15.00 %	10,597.60
2	NOVA U Crescent desk (L/H, with metal frame) W=1600 D=1200 H=740 M1 - White melamine M - Metallic *Narbutas  Model number : DNL160-U			
		176.88	12 - 10.00 %	1,910.30

Report

12,507.90

Page 1

Line	Short name	Unit Sale	Quantity	Price
				Report 12,507.90
3	NOVA U Crescent desk (R/H, with metal frame) W=1600 D=1200 H=740 M1 - White melamine M - Metallic *Narbutas			
				
	Model number : DNR160-U	176.88	12 - 10.00 %	1,910.30
4	OPTIMA Mobile pedestal (3 foil wrapped drawers, central locking) W=415 D=500 H=510 M1 - White melamine MK - Metallic *Narbutas			
				
	Model number : PSR532	84.02	24 - 10.00 %	1,814.83
5	CHOICE Cabinet (with lock, 3 shelves and fixed shelf) W=1000 D=420 H=1780 M1 - White melamine MX - Metallic 1 x PC0Z101-M Metal plinth for 1000mm wide cabinets W=1000 D=400 H=40 M - Metallic *Narbutas			
				
	Model number : C5C101	327.23	6 - 10.00 %	1,767.04

Euro

Total

18,000.07

GRAND TOTAL EUR

18,000.07

*** PLAĆANJE SE VRŠI PO IZDANOM PREDRAČUNU**
CIJENA NE UKLJUČUJE PDV!

ROK ISPORUKE U TJEDANA: CCA 6-8 TJEDANA OD DATUMA UPLATE

GARANCIJA: Steelcase nalazi se u nastavku ponude
Narbutas 5 godina

NAPOMENA: UKOLIKO SE NA ZAHTJEV KLIJENTA NARUDŽBA TREBA SKLADIŠTITI DUŽE OD 7 DANA (NAMJEŠTAJ)
PRIJE SAME ISPORUKE TROŠKOVE SKLADIŠTENJA SNOŠI KLIJENT. CIJENA OVISI O KOLIČINI ZAPRIMLJENE ROBE I
BITI ĆE ISKOMUNICIRANA PRIJE PRIHVACENE USLUGE SKLADIŠTENJA.

*SLIKA PROIZVODA JE SIMBOLIČNA

*Dostavu vršimo na području cijele Hrvatske. U slučaju otoka, dostava se vrši do najbliže trajektne luke.

NARUDŽBU JE MOGUĆE OTKAZATI U ROKU 2 DANA OD POTVRDE NARUDŽBE

UVJETI PLAĆANJA:
100% AVANSNA UPLATA

OVA PONUDA JE INFORMATIVNOG KARAKTERA.
VALJANOST PONUDE: 10 DANA OD DATUMA NA PONUDI.

STEELCASE WARRANTY*

YOU CAN DEPEND ON US. OUR PRODUCTS. OUR SERVICES. OUR PEOPLE.

Steelcase Inc. ("Steelcase") Global Products Warranty includes Steelcase®, Coalesse®, and Turnstone® brand products. Steelcase manufactures products for use around the world in every region. Products in two or more regions are "Global Products." The regional warranties (the Americas (including the United States, Canada, Mexico, the Caribbean, Central and South America), EMEA (Europe, except UK and Ireland, including Russian Federation, Middle East, Central Asia and Africa), United Kingdom and Ireland, and APAC (Asia Pacific) continue to apply for any product not included in the Global Products Warranty. Steelcase warrants that Global Products are free from defects in materials and workmanship. This warranty is valid from the date of delivery, regardless of shift usage, to the original End User and is non-transferable. Steelcase will repair or replace with comparable product, at its option and free of charge (for materials and components) any product, part or component which fails under normal use. If repair or replacement is not commercially practicable, Steelcase will provide a refund or credit for the affected product. End User means the final purchaser acquiring a product from

GLOBAL PRODUCTS - LIMITED WARRANTY

DESKS, TABLES, SCREENS, STORAGE AND

Steelcase: Bassline™, Bivi®, B-Free™, 4.8 Table, Fliptop Twin Table, Campfire® Big Lamp, Big Tables, Big Tables with trough and grommets, Paper Table, Personal Table, and Screens, c:scape®, Divisio Side Screen, FrameOne™/FrameOne Plus, High-Density Storage, Steelcase Flex, Flex Active Frames, Migration™, Migration™ SE, Ology™ Desk/Ology Bench, Verb™, Media:scape seating®, and Universal Storage.

Coalesse: CG_1™, Free Stand, Lagunitas™, Millbrae™, Montara650, Potrero415® ,Potrero415 Light, PowerPod, Sebastopol™, and SW_1®

Lifetime Warranty

Frame (except Coalesse), case/carcass, doors (except tambour), drawers (body and fronts), pulls/handles, supports, legs and base (except Coalesse), suspensions, carts, modesty panels, wire managers/cable trays, baskets, cup holder, dividers, rails, shelves, hanging folders bar, interlocks and locks

12 Year Warranty

Steelcase Flex, Migration, Migration SE, Ology Desk, and Ology Bench height-adjustable mechanisms and electronics, 4.8 Table, Fliptop Twin Table, Flex board clips, modular power/electrical power, mechanisms, casters, rollers, wheels and glides; Coalesse steel legs, and steel bases

5 Year Warranty

Tambour doors

3 Year Warranty

Coalesse/Steelcase electrical desktop, table top and rail mounted that houses power and/or data, and/or USB, Coalesse Free Stand mechanism and tablet, Coalesse SW1 table tablet including slide mechanism

SEATING

Steelcase: Amia™, B-Free, Buoy®, Brody™*, Campfire® Lounge, Ottoman and Wedge, cobī™, Gesture™, i2i™, Leap™, Node™, QiVi™, Reply™, Steelcase Flex, Steelcase Series®1, Steelcase Series®2, SILQ™, Shortcut®, Umami® and Think™
Coalesse: Enea™ Alto943, Hosu®, Lagunitas, LessThanFive™, Marien152, Massaud, Millbrae, Montara650, SW_1 and Visalia®

Lifetime Warranty

Frame (except Coalesse), seat shell, outerback, arm frame structure, base, stool

12 Year Warranty

Mechanisms, lumbar mechanisms, headrests, coat hanger, pneumatic cylinders/gas lifts, arm caps, foam, casters and glides, Node personal worksurface; Umami® frames, Coalesse lounge wood, bent-ply or steel frames

3 Year Warranty

Lagunitas articulating back, LessThanFive finish, SW_1 lounge tablet

*Brody electrical power is not covered in EMEA

SMART AND CONNECTED

media:scape®, ScapeSeries™

Lifetime Warranty

ScapeSeries and media:scape furniture components

1 Year Warranty

media:scape technology components

BOARDS AND EASELS

Steelcase Flex, Verb™

Lifetime Warranty

Verb whiteboards, docks, hooks, easels, storage caddy, and walltrack

12 Year Warranty

Verb teaching station lectern and plastic components

5 Years

Work Tents

3 Years Warranty

Flex markerboards, Flex Active Frames Mobile Board Clips

WORKTOOLS

SOTO™/1+1 Welcome Tools, Eyesite®/Plurio, CF/FSMA, Volley, and dash®

Lifetime Warranty

Mobile caddy, telephone caddy, binder holder, letter trays, launch pad non-powered and screen, functional screen, personal pocket; flat top hanger; wastebasket; footrest, mobile laptop support, laptop shelf, monitor bridge, ergo edge, and desk pad; cable clip, personal hook, toolbox, set of small

12 Year Warranty

Eyesite/Plurio, CF Series/FSMA, Volley, CPU supports and keyboard supports, lighting fixtures for dash

5 Year Warranty

Launch pad powered, lighting components for dash LED

3 Year Warranty

USB charging station, Eclipse Light

1 Year

Steelcase Flex Mobile Power

SURFACE MATERIALS

Refer to separate regional warranties for surface materials details.

Steelcase Warranty for Global Products

WARRANTY DOES NOT APPLY TO PRODUCT DEFECTS, DAMAGE, FAILURE OR LOSS RESULTING FROM:

- Normal wear and tear.
- Failure to apply, install, reconfigure, or maintain products according to published Steelcase or manufacturer instructions and guidelines.
- Abuse, misuse, or accident (including, without limitation, use of product in unsuitable environments or conditions).
- Alteration or modification of the product.
- The substitution of any unauthorized non-Steelcase components for use in the place of Steelcase components in an integrated product solution, including but not limited to worksurfaces, leg supports, panels, brackets, shelves, overhead bins and other integral components.

WARRANTY DOES NOT COVER:

- Products considered by Steelcase to be consumables; (e.g., batteries, bulbs/lamps).
- Other manufacturer's products, Steelcase shall pass along any warranty it receives with respect to other manufacturer's branded products.

• Pursuant to this limited warranty, if a product fails under ordinary use as a result of a defect in materials or workmanship, Steelcase will (i) repair or, at Steelcase's option, replace the affected product at no charge, with a new or refurbished product of comparable function, performance and quality or (ii) refund or credit of the purchase price for the affected product, at Steelcase's discretion, if

-- A product "defect" means an inadequacy in the materials or workmanship of the product that (i) existed at the date of delivery with respect to the product from Steelcase or a Steelcase Authorized Reseller to you and (ii) causes a failure of the product to perform under ordinary use in accordance with the materials and documentation accompanying the product.

-- An "ordinary use" means use of the product (i) in conformance with all applicable local, state, federal or national laws, codes and regulations (including without limitation building and/or electrical codes) and (ii) in accordance with manufacturer recommendations and/or instructions in the materials and documentation accompanying the product.

-- A "Steelcase Authorized Reseller" means any dealer that (i) is duly authorized by Steelcase to sell the product, (ii) is legally permitted to conduct business in the jurisdiction where the product is sold,

• Replacement parts are covered for 2 years or the balance of the original warranty, whichever is longer.

WARRANTY PROVIDES EXCLUSIVE REMEDIES:

In the European Union (EU), Steelcase participates in recycling networks for Waste Electronic and Electrical Equipment (WEEE) and pays for the associated administrative and recycling costs. EU-customers are responsible for collection and delivery of WEEE to the recycler identified by Steelcase, unless this responsibility is prohibited by national law.

WITHOUT PREJUDICE TO THE LEGAL WARRANTIES PROVIDED UNDER NATIONAL LAW, THIS LIMITED WARRANTY IS THE SOLE REMEDY FOR PRODUCT DEFECT AND NOT OTHER EXPRESS OR IMPLIED CONTRACTUAL WARRANTY IS PROVIDED, INCLUDING BUT NOT LIMITED TO ANY IMPLIED WARRANTIES OF MERCHANTABILITY OR FITNESS FOR A PARTICULAR PURPOSE. STEELCASE SHALL NOT BE LIABLE FOR ANY

Steelcase

©2021 Steelcase Inc. All rights reserved.
All specifications subject to change without notice.

STEELCASE WARRANTY for Europe Middle East - Central Asia- Africa

(except UK /

YOU CAN DEPEND ON US. OUR PRODUCTS. OUR SERVICES. OUR PEOPLE.

Global Products are warranted in accordance with the Steelcase® Global Products Warranty. The list of Global Products are found in the Global Products Warranty. This Regional Warranty applies exclusively to products that are not Global Products. This warranty applies only to products delivered in Europe (except United Kingdom and Ireland) including Russian Federation, in Middle-East, in Central Asia and in Africa. Without prejudice to the legal warranties provided under national law, Steelcase Inc. ("Steelcase") warrants that Steelcase® and Coalesse® brand products are free from defects in materials or workmanship for a period of eight (8) years except as set forth below. The warranty is valid from the date of delivery to the original End User and is non-transferable. Steelcase will repair or replace with comparable product, at its option and free of charge (for materials and components) any product, part or component which fails under normal use. If repair or replacement is not commercially practicable, Steelcase will provide a refund or credit for the affected product. End User means the final purchaser acquiring a product from Steelcase or a Steelcase Authorized Reseller for the purchaser's own use and not for resale, remarketing or distribution. This

EXCEPTIONS

SYSTEMS, STORAGE, DESKS, TABLES AND BENCHING

5 years
All non-electrical mechanisms, foam
2 years
Electrical desk adjustments, markerboards, electronic locks

WORKTOOLS

2 years
Special products, electrical components, electronic components and lighting elements

SEATING

5 years
Chair gas lifts, Gesture™ and Leap™ 24/7 Chair with shifts use, foam
3 years
Gesture and Leap 24/7 Chair with Fame fabric in 3 shifts use

SURFACES

5 years
Textiles, decors and other coverings (excluding wood veneer)
3 years
Wood veneer, leather (excluding armrest covers), Coalesse glass, Fusion Coalesse surfaces, Coalesse SW_1® knit, Coalesse Elmosoft Leather, Silk fabric

IMAGE & MANAGEMENT

3 years
Image and Management products, except electrical components, electronic components and light elements
2 years
Image and Management electrical components, electronic components and light elements

STEELCASE WARRANTY for Europe Middle East - Central Asia- Africa

(except UK /

WARRANTY DOES NOT APPLY TO PRODUCT DEFECTS, DAMAGE, FAILURE OR LOSS RESULTING FROM:

- Normal wear and tear.
- Failure to apply, install, reconfigure, or maintain products according to published Steelcase or manufacturer instructions and guidelines.
- Abuse, misuse, or accident (including, without limitation, use of product in unsuitable environments or conditions).
- Alteration or modification of the product.
- The substitution of any unauthorized non-Steelcase components for use in the place of Steelcase components in an integrated product solution, including but not limited to worksurfaces, leg supports, panels, brackets, shelves, overhead bins and other integral components.
- Use in more than a single shift per day; in which case, the warranty is reduced accordingly (except for Gesture and Leap 24/7 chair see Exception section).

WARRANTY DOES NOT COVER:

- Products considered by Steelcase to be consumables (e.g., batteries, lamps, except projector lamps offer 6 months coverage).
- Armrest covers with leather are not covered.
- Variations occurring in surface materials (e.g., colourfastness, sheen on veneer surfaces or matching grains, textures and colors across dissimilar substrates and lots).
- Select Surfaces (fabric) and Customer's Own non-standard textiles and materials (COM) are not covered, except as warranted by the original supplier, for material properties including, but not limited to, quality, colourfastness, shade variations, puddling, wrinkling or abrasions.
- Other manufacturer's products (Steelcase will pass along any warranty it receives with respect to other manufacturer's branded products, including Officebricks and Viccarbe).

In the European Union (EU), Steelcase participates in recycling networks for Waste Electronic and Electrical Equipment (WEEE) and pays for the associated administrative and recycling costs. Our EU customers are responsible for collection and delivery of WEEE to the recycler identified by Steelcase, unless this responsibility is prohibited by national law.

Steelcase reserves the right to request that the damaged product be returned prior to granting a remedy.

The warranty is non-transferable and only applies to the first-time purchaser who purchased the product from Steelcase or a Steelcase Authorized Dealer for its own benefit and not for resale, remarketing or redistribution.

WITHOUT PREJUDICE TO THE LEGAL WARRANTIES PROVIDED UNDER NATIONAL LAW, THIS LIMITED WARRANTY IS THE SOLE REMEDY FOR PRODUCT DEFECT AND NO OTHER EXPRESS OR IMPLIED CONTRACTUAL WARRANTY IS PROVIDED, INCLUDING BUT NOT LIMITED TO ANY IMPLIED WARRANTIES OF MERCHANTABILITY OR FITNESS FOR A PARTICULAR PURPOSE. STEELCASE SHALL NOT BE LIABLE FOR ANY CONSEQUENTIAL, SPECIAL, PUNITIVE, OR INCIDENTAL DAMAGES.

WARRANTY PROVIDES EXCLUSIVE REMEDIES:

- Pursuant to this limited warranty, if a product fails under ordinary use as a result of a defect in materials or workmanship, Steelcase will (i) repair or, at Steelcase's option, replace the affected product at no charge, with a new or refurbished product of comparable function, performance and quality or (ii) refund or credit of the purchase price for the affected product, at Steelcase's discretion, if Steelcase determines that repair or replacement is not commercially practicable or cannot be timely made.

- A product "defect" means an inadequacy in the materials workmanship

of the product that (i) existed at the time when you received the product from Steelcase or a Steelcase Authorized Reseller and (ii) causes a failure of the product to perform under ordinary use in accordance with the materials and documentation accompanying the product.

- An "ordinary use" means use of the product (i) in conformance with all applicable local, state, federal or national laws, codes and regulations (including without limitation building and/or electrical codes) and (ii) in accordance with manufacturer recommendations and/or instructions in the materials and documentation accompanying the product.

- A "Steelcase Authorized Reseller" means any dealer that (i) is duly authorized by Steelcase to sell the product, (ii) is legally permitted to conduct business in the jurisdiction where the product is sold, and (iii) sells the product new and in its original packaging.

- A Consumer means any individual client who acts for its own use and for purposes that are outside its trade, business, craft or profession.

- Replacement parts are covered for 2 years or the balance of the original warranty, whichever is longer.

Steelcase

©2022 Steelcase Inc. All rights reserved.
All specifications subject to change without notice.

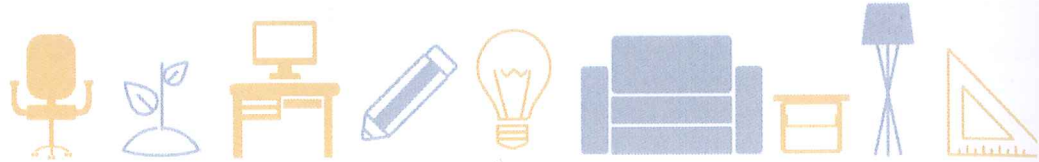

IZJAVA

Ovom Izjavom potvrđujemo da smo u skladu sa svim propisanim uvjetima natječaja, te da zadovoljavamo sve tehničke specifikacije traženih proizvoda.



Zoran Arsov, direktor

Delight d. o. o.

 Radnička cesta 52
10000 Zagreb
Hrvatska
 +385 1 4623063
 office.croatia@delightoffice.com
 www.delightoffice.hr

OIB (VAT): 80012427201
MBS (Reg. No.): 080487057
Transakcijski račun (current account): HRK: HR2924070001100528939
EUR IBAN: SHR2924070001100528939, OTP banka d.d., Split, Hrvatska (Croatia)
SWIFT: OTPVHR2X

www.delightoffice.com

FOR A
BETTER DAY
@ WORK

Steelcase®

Steelcase Series® 1
Office Chairs

Steelcase Series 1 gives you essential ergonomics and quality at a great value. This high-performance office chair boasts space efficiency, weight-activated controls and an even more sustainable option.



Ergonomics for Everyone

Steelcase Series 1 offers an exceptional entry point into high-performance ergonomic office seating and weigh-activated or manual tension adjustments – customized to fit you.



Delivering on What's Important

Performance, style and choice. Choose from plenty of back, seat and frame color choices to create the perfect chair to fit you and your space. Steelcase Series 1 is where serious support, lighthearted looks and exceptional value all come together—a different class that's still best-in-class.



Performance Features



Two Mechanisms

Features a weight-activated synchro mechanism that allows for automatic and intuitive adjustments OR a Manual synchro mechanism that allows for precise adjustments, and personal comfort.



Fully Adjustable Arms

Standard 4-dimensional arm support adjusts to preferred height, width, depth, and pivot.



Lumbar Support

Additional adjustable lumbar support comes as standard.



Seat Ergonomics

Seat is height- and depth-adjustable. Flexible edges and adaptive bolstering in the seat foam provide pressure-free comfort.



Seat Angle Adjustment

Steelcase Series 1 offers an adjustable seat angle for users who want more posture options.

Product Range



Task chair



Draughtsman Chair

Features + Options

Options



Arms (1D, 4D, Armless)



Adjustable Headrest



Coat Hanger



Seat Angle Adjustment*

Base



Polished Aluminium Base



Plastic Base

* Only with manual synchronized mechanism

Back Styles



3D Microknit



Upholstered

Surface Materials

Lumbar/Flexor

Microknit Finishes:

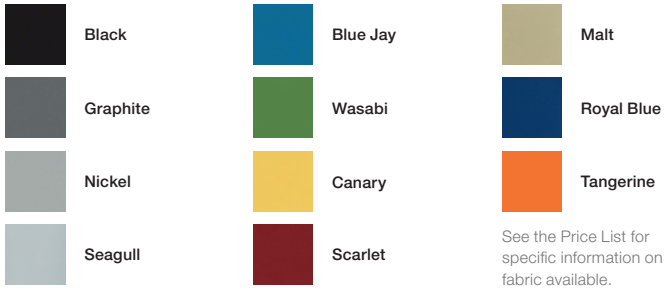

Upholstered Back Finishes

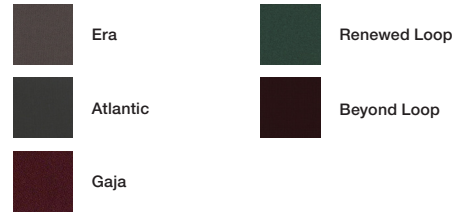

Dimensions

Seat height:	410-520mm
Adjustable seat depth:	420-480mm
Seat pad depth:	450mm
Seat pad width:	440mm
Adjustable height of lumbar support:	150-240mm
Back height:	550mm
Back width:	460mm
Height of armrests from seat:	185-285mm
Arms rotation range (4D):	40°-40°

(following EN 1335-1:2020 Office work chair)

Availability + Manufacturing

Steelcase Series 1 is manufactured by Steelcase in Sarrebourg, France (ISO 9001, ISO 14001, ISO 45001, ISO 50001, and PEFC (PEFC/10-31-1050) for the EMEA market (Europe, Middle East and Africa). It is also available in the Americas and Asia Pacific.

Product Certifications + Declarations

- SCS Indoor Advantage™ Gold
- NF Environnement
- GS Zertifikat
- NF OEC Office Excellence
- EPD (Environmental Product Declaration)
- PEP (Product Environmental Profile)
- CarbonNeutral® product certification (available as an option)
- EN 1335-1:2020
- EN 1335-2:2020

Additional Product Materials



NOVA U desks



H 740



L 1200; 1400; 1600; 1800
W 700; 800



L 1200; 1400
W 600



L 2400; 2800; 3200; 3600
W 800



L 1200; 1400; 1600; 1800
W 800



L 1200; 1400; 1600; 1800
W 1440; 1640



L 2400; 2800; 3200; 3600
W 1440; 1640



L 1200; 1400; 1600; 1800
W 1440; 1640



L 1400; 1600; 1800
W 1200



Ø 2810



L 800
W 600



L 600
W 800



L 1440; 1640
W 600

Possibility to extend the length of the 2 or 4 desk bench by ordering supplementary units.
We recommend to connect up to 6 back to back units.

FEATURES

- Easy to assemble and disassemble - "metal to metal" construction
- Just one tool for assembling (DIN911 S5)

QUALITY STANDARD

- LST EN 527-1:2011
- LST EN 527-2:2017
- LST EN 1730:2012

TECHNICAL INFORMATION

Desktop

- 25 mm MFC (melamine) with 2 mm ABS edging;
- 10 mm gap between the legs and the desktop;
- 40 mm gap between the desktops in back to back benches (depth of benches – 1440/1640).

Metal beam

- Metal tube - 40x20 mm;
- With welded metal plates for leg fixing;
- Powder coated metal, colour matches the legs.

Legs

- Welded metal tube - 40x40 mm;
- Powder coated metal;
- Plastic feet with height levelling (+10 mm).

Desktop type



Plain desktop



Desktops with a scallop for wire management



Desktops with a cut-out for grommet and wire management

GUARANTEE

- 5 years

Must be ordered

(for desktop with cut-out)

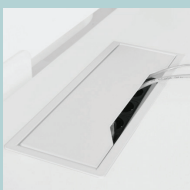

Metal grommet:
317x119 mm,
H=27 mm

Optional



Power socket blocks



Cable trays



Cable clips

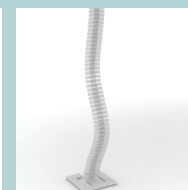

Cable ducts

CHOICE

Technical information

narbutas.com



Other documents available for this product

NARBUTAS product care guide

10 year Warranty

See Warranty statement



Technical information

Types

- Bookcases (1)
- Cabinets and wardrobes (2)
- Cabinets and wardrobes with sliding doors (3)
- Cabinets with drawers and shelf (4)

1



2



3



4



Bookcases (1)

Sides, top, bottom and back panel

- Sides, top and bottom - 18 mm MFC (melamine) with 1 mm ABS edging;
- Back panel - 18 mm MFC (melamine).

Shelves

- 18 mm MFC (melamine) with 1 mm ABS edging. Load capacity: 20 kg;
- 25 mm MFC (melamine) with 2 mm ABS edging (for W=1000 mm wide carcass). Load capacity: 20 kg;
- Fixed shelves;

Fittings

- CAMS with connecting bolts.

Cabinets and wardrobes (2)

Sides, top, bottom and back panel

- Sides, top and bottom - 18 mm MFC (melamine) with 1 mm ABS edging;
- Back panel - 18 mm MFC (melamine).

Shelves

- 18 mm MFC (melamine) with 1 mm ABS edging. Load capacity: 20 kg;
- 25 mm MFC (melamine) with 2 mm ABS edging (for W=1000 mm wide carcass). Load capacity: 20 kg;
- Fixed or height-adjustable shelves;
- Pull-out coat hanger, load capacity: 3 kg.

Doors

- Doors with hinges in 18 mm MFC (melamine) with 1 mm ABS edging.

Fittings

- CAMS with connecting bolts;
- Fast assembling hinges (does not require any tools to connect hinges to plates);
- 107° opening angle with soft closing function.

Lock

- Cylinder lock without retention and 2 keys;
- Lock without metal bars.

Cabinets and wardrobes with sliding doors (3)

Sides, top, bottom and back panel

- Sides, top and bottom - 18 mm MFC (melamine) with 1 mm ABS edging;
- Back panel - 18 mm MFC (melamine).

Shelves

- 18 mm MFC (melamine) with 1 mm ABS edging. Load capacity: 20 kg;
- 25 mm MFC (melamine) with 2 mm ABS edging (for W=1000 mm wide carcass). Load capacity: 20 kg;
- Fixed or height-adjustable shelves;
- Pull-out coat hanger, load capacity: 3 kg.

Doors

- Sliding doors in 18 mm MFC (melamine) with 1 mm ABS edging.

Fittings

- CAMS with connecting bolts;
- Lock without metal bars;
- Plastic runners.

Lock

- Cylinder lock without retention and 2 keys.

Cabinets with drawers and shelf (4)

Options

- Right-handed (drawers on the right, shelf on the left);
- Left-handed (drawers on the left, shelf on the right).

Sides, top, drawer front, bottom and back panel

- Sides, top, drawer front and bottom - 18 mm MFC (melamine) with 1 mm ABS edging;
- Back panel - 18 mm MFC (melamine);
- Top - 25 mm MFC (melamine) with 2 mm ABS edging

Shelf

- 18 mm MFC (melamine) with 1 mm ABS edging. Load capacity: 20 kg;
- Shelf in the open space can be adjusted vertically by 160 mm;
- Maximum load capacity per cabinet: 80 kg.

Top drawer

- Drawer box made of 16 mm MFC (melamine) with 1 mm edging (ABS);
- Dimensions: 722x308, H= 66 mm (box, inner);
- Load capacity: 15 kg;
- Soft closing function, lockable, full extension with hidden slides.

File drawer

- Suitable for letter, A4, or foolscap files (309 mm; 330 mm or 386 mm width);
- Drawer box made of 16 mm MFC (melamine) with 1 mm edging (ABS);
- Dimensions: 722x308, H=245 mm (box, inner);
- Soft closing function, locks with central locking, full extension with hidden slides;
- Load capacity: 25 kg.

Fittings

- CAMS with connecting bolts.

Lock

- Cylinder lock without retention and 2 keys;
- Lock with metal bar.

Handles

- Handles (EG, MG, AG, T1G) made from powder-coated metal, hole for fixing – 128 mm (1);
- Handles (EX, MX, AX, T1X) made from powder-coated metal, hole for fixing – 128 mm (2);
- Recessed handles 145x42x15 mm (EC, MC, AC, T1C) from aluminium, powder coated (3).

1

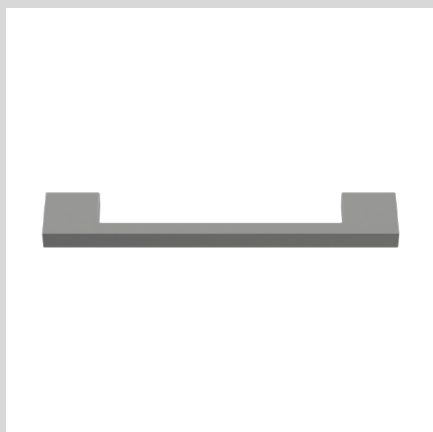

2

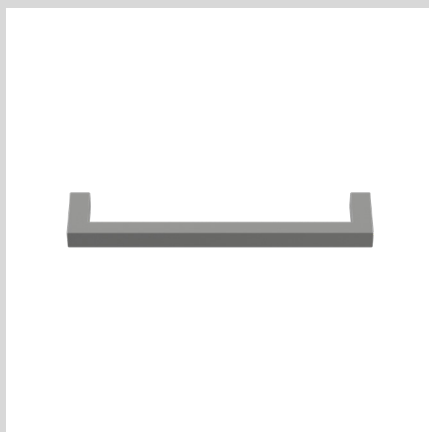

3

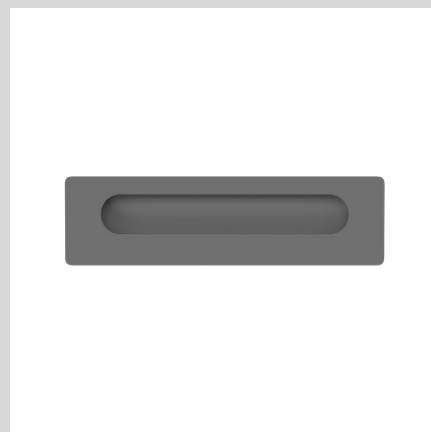

Bases (must be ordered)

Plinth MFC (1)

- Right-handed (drawers on the right, shelf on the left);
- Left-handed (drawers on the left, shelf on the right).

Plinth metal (2)

- Made from welded metal tube, H=40 mm;
- Height levelling legs +10 mm.

Metal legs (3)

- Metal tube - 20x20 mm;
- Plastic legs with height levelling, H=80 mm +10 mm;
- Powder coated metal.

Metal legs with frame (4)

- Welded metal tube - 20x20 mm;
- Plastic legs with height levelling, H=150 mm +10 mm;
- Powder coated metal.

Plastic legs (5)

- Black plastic height levelling legs, H=17 mm +10 mm.

Solid wood legs (6)

- Lacquered and stained light grey or black ash solid wood base, H=150 mm;
- Height levelling +10 mm.

Castors (7)

- Four twin wheel castors, Ø80 mm;
- Two out of four with stopper brakes;
- Maximum load capacity: 100 kg per castor.

1



2



3



4



5



6



7



Additional parts (optional)

MFC shelf/shelf with dividers (1)

- 18/25 mm MFC (melamine) with 1 mm ABS edging;
- Chromed metal dividers (7pcs.) (only for shelves with dividers).

Metal shelves (2)

- 28 mm (shelf thickness), made of welded metal sheet. Load capacity: 30 kg.

Lateral filing metal shelf (3)

- 28 mm (shelf thickness), made of welded metal sheet. Load capacity: 30 kg.

Pull out black metal filing cradle (4)

- File drawers for both A4 and foolscap files;
- Full extension with anti-tilt function;
- Made of welded metal sheet, without bottom. Powder coated (black);
- Ball bearing slide, load capacity: 30 kg.

Wire Frame for foolscap / A4 (frame-mounted binders) (5)

- Dimensions: W=340 mm, D=305 mm, H=245 mm;
- Galvanized wire with black plastic corners.

Shelves for letters (Pigeon holes) (6)

- Sides, top, drawer front and bottom - 18 mm MFC (melamine) with 1 mm ABS edging;
- Back panel - 18 mm MFC (melamine).

Plastic drawer (Pencil tray) (7)

- Tray from black plastic: W=380 mm (with mounting brackets), L=375 mm, H=32 mm;
- Ball bearing slide full extension;
- Mounted under cabinet top or shelves;
- Load capacity: 2 kg (EN 15338).

Drawer's box (8)

- 12 mm MFC (melamine) with 0,5/1 mm ABS edging;
- 10 mm plywood with HPL;
- 3 drawers with soft closing function, full extension with hidden slides;
- Not suitable for 800 mm wide cabinets with sliding doors.

1



2

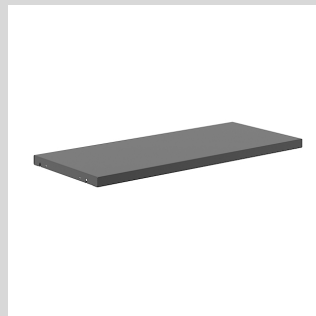

3

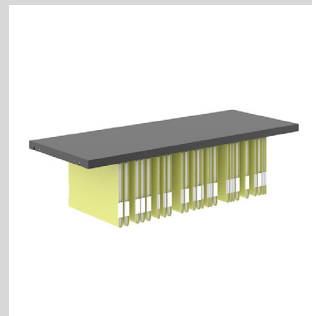

4



5

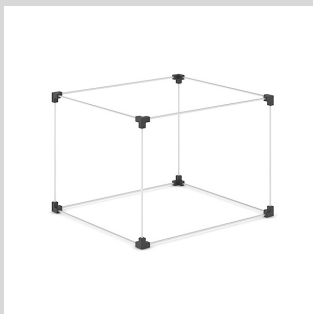

6



7



8



Planter box (9)

- 18 mm MFC (melamine) with 1 mm ABS edging;
- Load capacity for 800 mm width: 20 kg;
- Load capacity for 1000 mm width: 20 kg;
- Load capacity for 1200 mm width: 35 kg.

Cushion (10)

- 4 different sizes: 802x429x32 mm, 808x404x32 mm, 1010x404x32 mm, 1212x404x32 mm;
- Cushions are for 1H and 2H cabinets. They are fixed on the top of the cabinet using Velcro tape;
- Two cushions (808) are needed for cabinets with width of 1600 mms;
- HR5050 foam rubber is used in pillow production.

Fabric back panel (11)

- HDF 3 mm coated with foam 3 mm and fabric (fixing with glue stickers).

PET back panel (12)

- PET felt board 9 mm (fixing with glue, must be ordered separately).

Side and top panels (13)

- 16 MFC with 1 mm ABS edging;
- 16 mm chipboard, covered in wood veneer with 1,5 mm edging.

Keys for locks (14)

- Master key – provides lock access in case of forgotten/misplaced key;
- Removal key – allows removal of locks cylinder from the door;
- Cylinder lock with 2 keys – can be used to change the lock in case of lost keys.

Counterweight (15)

- 8 mm powder-coated metal plate (grey colour by default), fixed with screws under the bottom;
- 25 mm MFC (melamine) with two 0,5 mm ABS edges, fixed with stickers to the back panel inside the cabinet.

Stickers (16)

- Adhesive stickers (H=0,13 mm) for fixing one cabinet on top of another without any tools.

9

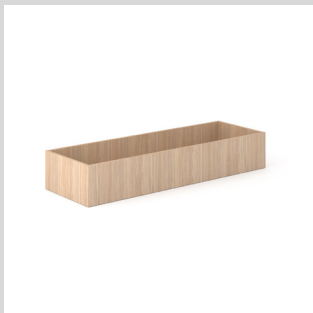

10



11

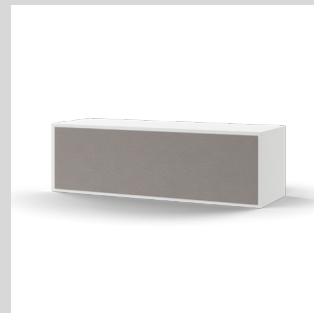

12

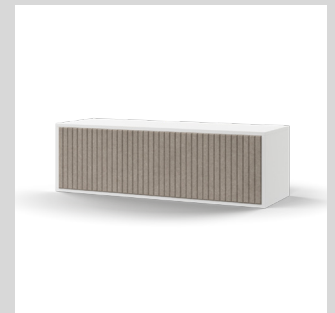

13



14



15



16

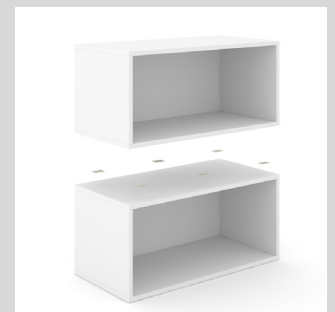

Range

Bookcases

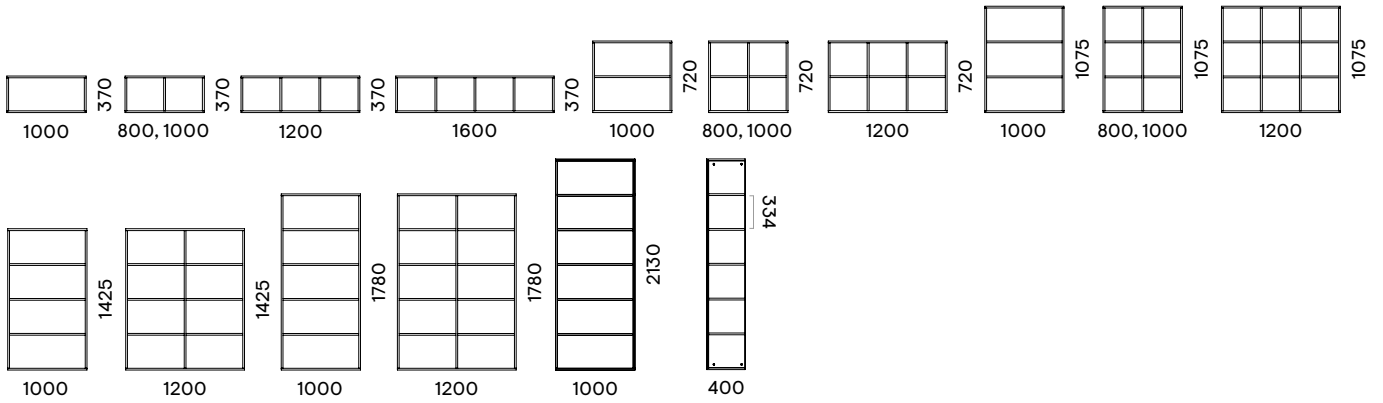

Cabinets and wardrobes

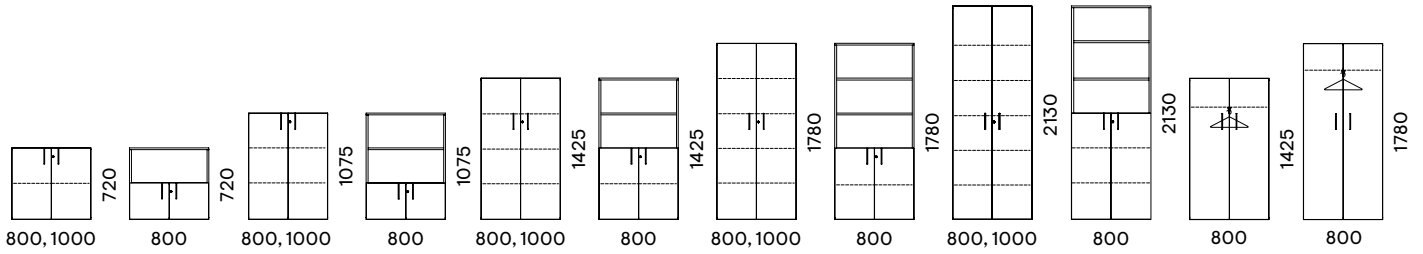

Cabinets and wardrobes with sliding door

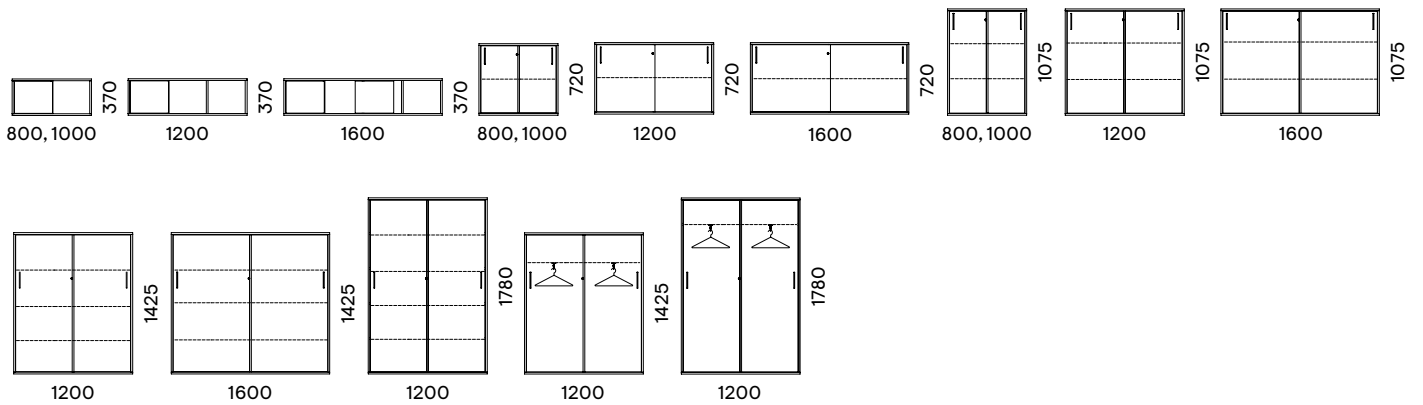

Cabinets with drawers and shelves

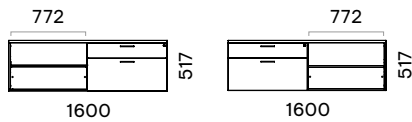

Planter box

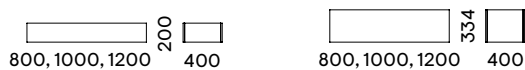

Additional information

Fixing one cabinet onto another

- The overall height of the cabinet will increase by 18 mm when placing one cabinet on top of the other (e.g. 1H+1H). This may result in differing overall heights between the cabinets or desks.
- Side panels will not be suitable for cabinet combinations.



- Please note glue on the stickers takes time to harden (50% in 15 min, 90% in 24 h and 100% in 72 h). It is advised to wait before first using the cabinet. Splitting the cabinets again by carefully removing the top part and cleaning the residual glue with everyday cleaning solvent (e.g. turpentine) is possible.
- Tips for fixing one cabinet onto another:
 - If the combination is higher than 3H, it is recommended to choose a solid base, e.g. metal plinth or plinth with metal frame;
 - Compositions exceeding 5H height must be mounted to the wall;
 - Additional mounting to the wall and strengthening with wood screws is recommended for cabinets with hinged doors or drawers.

Cabinet fixing

- 6H cabinets always must be fixed to the wall. Wall mount fittings are included with 6H cabinets, additional order is not required. Mounting to the wall is chosen by installer according to the wall type.



Planter box fixing

- Planter boxes are attached to the top panel with screws. Screws are included in the kit.



Colour of the connection

- Bookcase (C4N120, C5N120, C6N120), cabinets (C3S160, C4S120, C4S160, C5S120) and wardrobes (C4S121, C5S121) have visible connection on the backside.
- When ordering bookcase in two colours (C4N120, C5N120, C6N120), the colour of the connection will also be visible on the backside of the cabinet.



Sliding doors

- In the open position, the sliding inner (right) door is visible. There is a gap of 25 mm between the handle and the edge of the left door. Door brakes can be re-assembled (only for cabinets with type “C” handle) if required, and the door will fully open (more information in assembly scheme).



Shelves

- At least one fixed shelf (COZO34, COZO345) or one metal shelf (COZO38, COZO39) must be ordered with 4H, 5H and 6H cabinets with doors and without shelves.
- Shelf adjustment:
 - Bookcase shelves are always fixed;
 - Cabinets and wardrobes 4H-6H have one fixed shelf on the level of the handle (used for locking). Other optional or included shelves can be adjusted in a free space every 32 mm, leaving a minimum ~170 mm space on top and bottom.

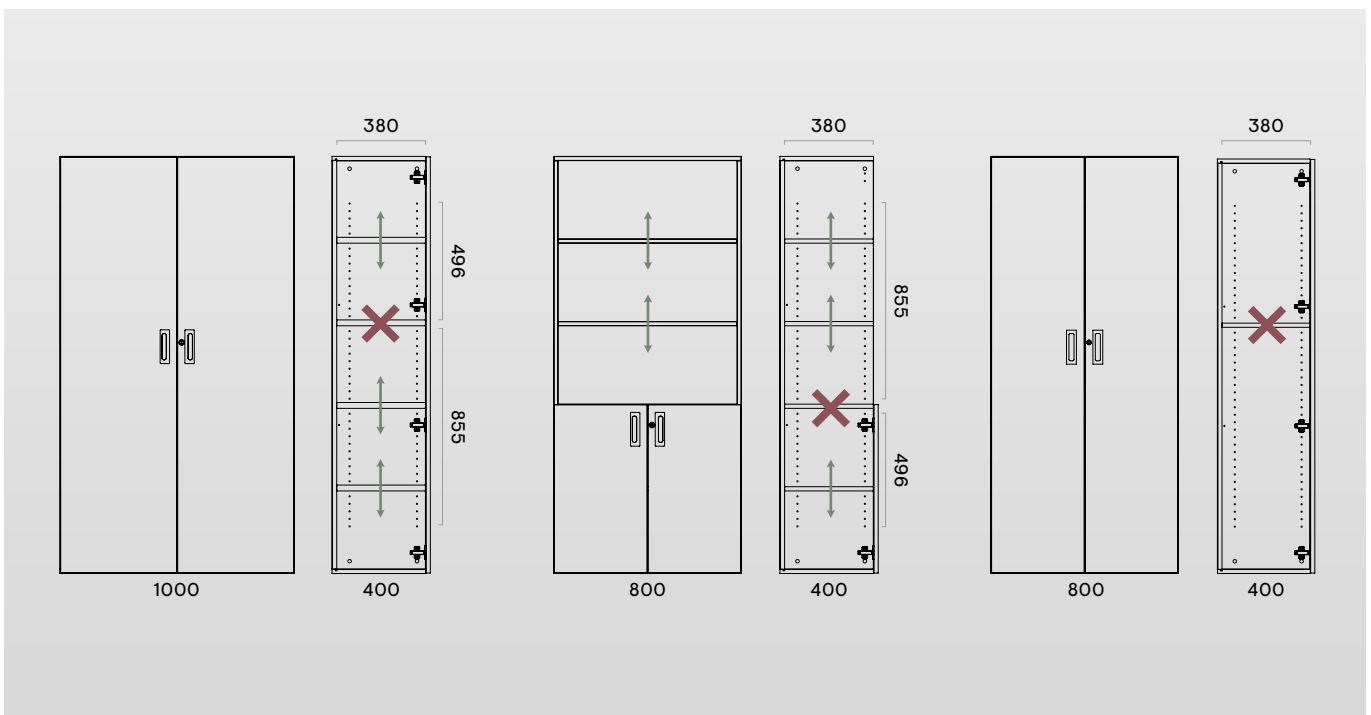

- Cabinets with drawers shelves in the open space can be adjusted vertically by 160 mm;

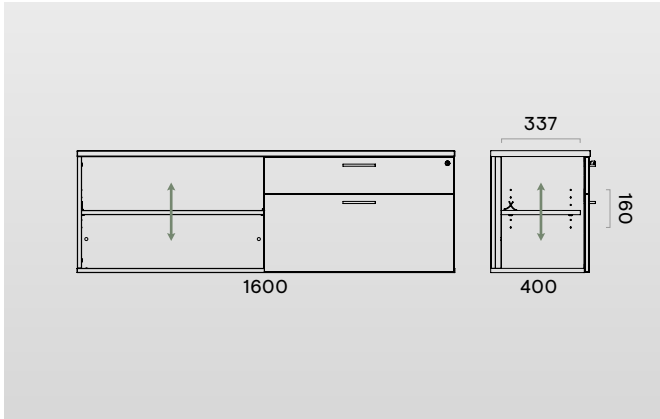

- Additional shelves can be ordered for the lower part of the wardrobe.



Bases

- All bases (plinth, legs, etc.) are slightly recessed from the back of the cabinet due to storage stability and design. Please note that the cabinet cannot be placed against the wall completely if there is a floor plinth.



- Central legs (C0Z004, C0Z122, C0Z162, C0Z006) of 1200 mm and 1600 mm width cabinets can be mounted in 2 positions, so it is possible to choose the less visible option.



- Cabinets with drawers and shelves (C2S150; C2S151) cannot be ordered with plinths.

Back panels

- Bookcases and cabinets with sliding doors are 400 mm deep. MFC back panels are 420 mm deep and will stand out by 20 mm.

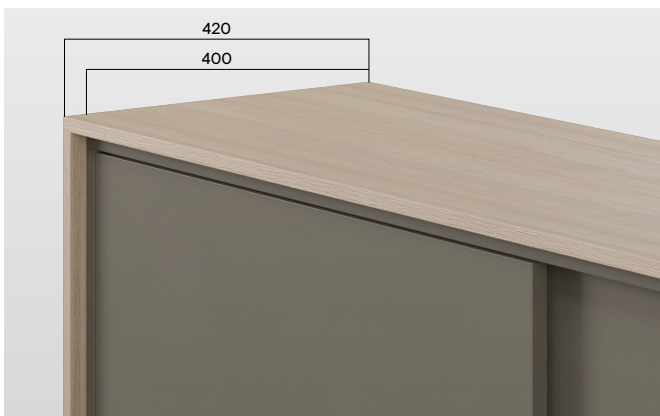

- Fabric and PET back panels of 3H and higher cabinets (C3S160, C4N120, C4S120, C4S121, C4S160, C5S120, C5S121) are made of two pieces.



Cushion

- Cushion is suggested for 1H and 2H cabinets and only for short sitting periods. 1H and 2H cabinets can hold up to 110 kg.



Additional parts (“Pigeon holes”)

- Not suitable for bookcases with vertical dividers;
- Not suitable for wardrobes;
- Not suitable for cabinets with sliding doors;
- Important! Please note that “Pigeon holes” weigh about 8 kg and should be factored in the shelf and cabinet loading capacity;
- Shelves must be adjusted according to “Pigeon holes” height (334 mm).

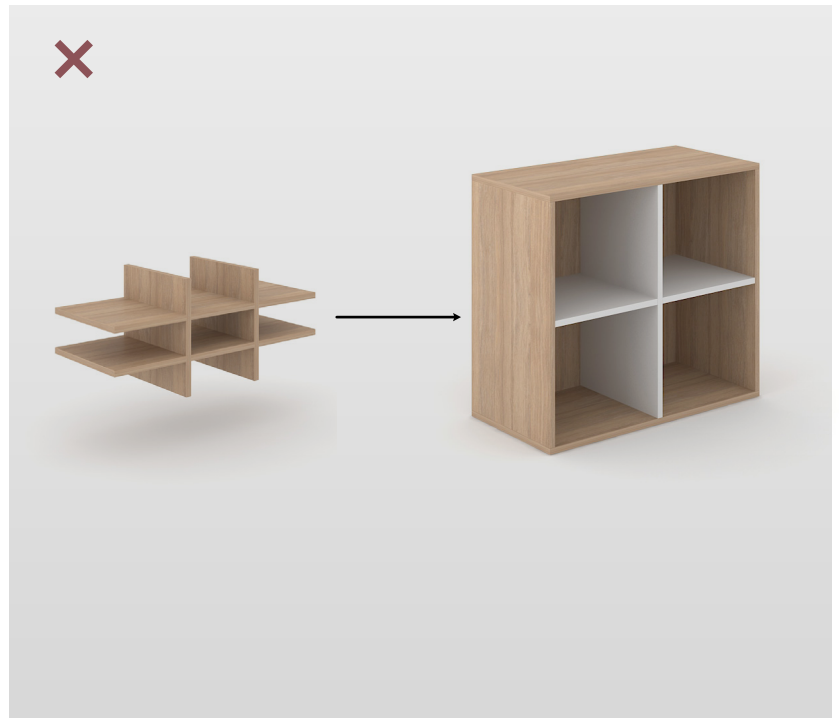

A4 suspension files

- A4 suspension files can only be hung on lateral filing metal shelves in cabinets with hinged doors. The suspension files in cabinets with sliding doors will not fit on metal shelves (COZO40, COZO41, COZO42, COZO43).



Pull-out metal filing cradles

- When ordering cabinets with pull-out metal filing cradles, it is recommended to order counterweights or fix cabinets to the wall or other stable furniture. Please note that in the set of metal pull-out filing cradles (2 pcs.), there is an anti-tilt mechanism, i.e. both cradles cannot be open simultaneously.
- If ordering 2 or more cradles, largest possible number of anti-tilt sets must be ordered (ex. If ordering 4 cradles – order 3-unit set with anti-tilt + 1 without anti-tilt. If ordering 5 cradles – 3-unit set with anti-tilt + 2-unit set with anti-tilt).











































- At least one fixed melamine or metal shelf must be ordered with 4H, 5H and 6H cabinets, disregarding number of cradles.



Planter box care

- Please note that the inner part of the planter box is not protected from moisture. It is recommended to follow the Melamine or Veneer cleaning and care instructions.

Stability measures

	2H	3H	4H	5H	6H
Quantity of pull-out metal filing cradle					
 x1	!  / 	!  / 	 / 	 / 	! 
 x2	!  / 	!  / 	 / 	 / 	! 
 x3	×	!  / 	 / 	 / 	! 
 x4	×	×	×	! 	! 
 x5	×	×	×	×	! 

!  /  Must be ordered. Please order the counterweight or fix cabinets to the wall / other stable furniture.

 /  It is recommended to order the counterweight or fix cabinets to the wall / other stable furniture.

Note! For cabinets with plastic legs it is necessary to order the counterweight or fix cabinets to the wall / other stable furniture.

!  Must be fixed. Please fix cabinets to the wall / other stable furniture.

× Not available.

OPTIMA pedestals

QUALITY STANDARD

- LST CEN/TR 14073-1:2004
- LST CEN/TR 14073-2:2004
- LST EN 14074:2004

TECHNICAL INFORMATION



**MOBILE
PEDESTALS**



**DESK HEIGHT
PEDESTALS**



**FILING
PEDESTALS**



**FIXED
PEDESTALS**

Carcass

- Made of 16 mm MFC (melamine), 1 mm ABS edging;
- PEX627, PEX637, PEX647 made of 18 mm MFC (melamine), 1 mm ABS edging.

Feet

- Plastic height levelling feet, H=38 mm +10 mm (OPTIMA PLUS);
- H=23 mm +10 mm (PSS, PEX series).

Castors

- Twin wheel castor \varnothing 37 mm;
- Max. 50 kg per castor.



Pencil tray ZZZ004
Suitable for pedestals PSR540, PSR525, PSP525, PSR541,
PSR532, PSR535, PSP532.

Additional options

- Drawers: foil wrapped drawer, metal-sided drawer, file drawer, full extension file drawer;
- First pencil drawer can be made from plastic;
- Locking: first drawer lock or central locking;
- Anti-tilt mechanism;
- Top made of 25 mm MFC (melamine) with 2 mm ABS edging or 16 mm MFC (melamine) with 1 mm ABS edging.



Handle type (colour + handle code)



Pencil tray for metal sided drawers ZZZ006
Suitable for pedestals PUS642, PUS635, PUS835, PUR636,
PUR637.

RANGE

Mobile pedestals

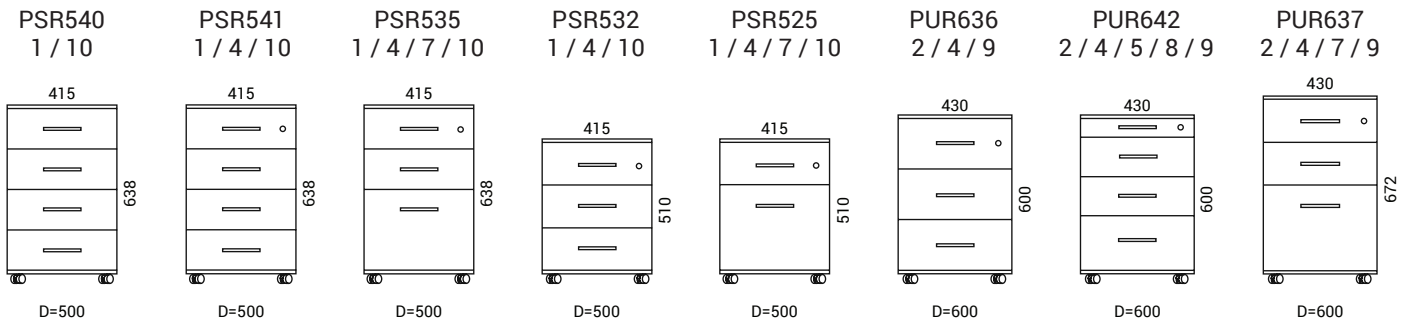

Desk height pedestals

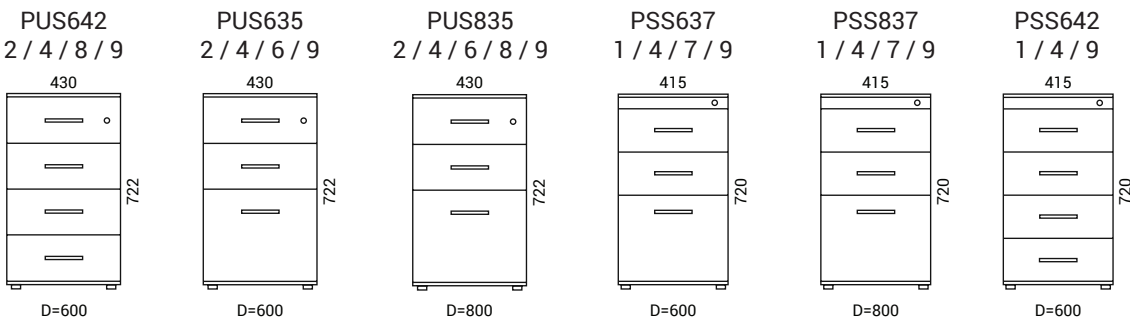

Filing pedestals

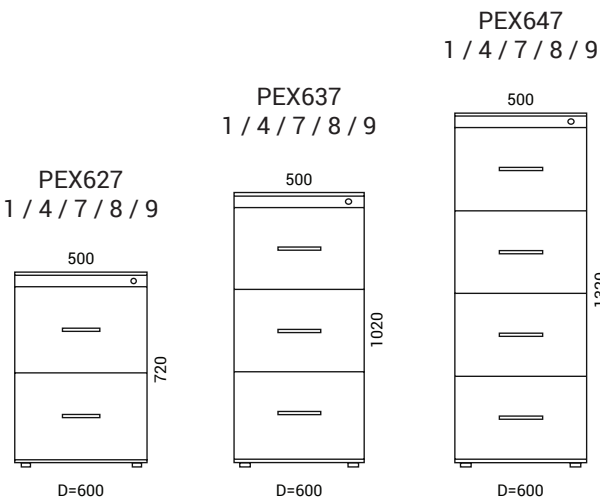

Fixed pedestals

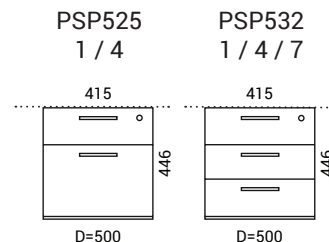

1. Foil wrapped drawers: sides made from white 12 mm MFC (melamine), bottom made from white 4 mm fiberboard. L=450 mm. Load max. 15 kg;
2. Metal-sided drawers: bottom and back made from white 16 mm MFC (melamine). L=500 mm. Load max. 25 kg;
3. First drawer lock;
4. Central locking;
5. First pencil drawer from plastic;
6. File drawer;
7. Full extension file drawer suitable for A4 or foolscap filing;
8. Anti-tilt mechanism;
9. Top made of 25 mm MFC (melamine), 2 mm ABS edging;
10. Top made of 16 mm MFC (melamine), 1 mm ABS edging.

Optional



Plastic pencil tray

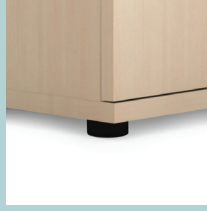

Plastic legs (5 pcs.)



Additional base elements with height adjustment

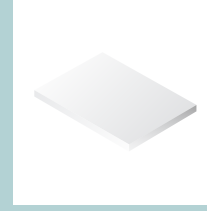

Top for desk height pedestals

STEELCASE WARRANTY*

YOU CAN DEPEND ON US. OUR PRODUCTS. OUR SERVICES. OUR PEOPLE.

Steelcase Inc. ("Steelcase") Global Products Warranty includes Steelcase®, Coalesse®, and Turnstone® brand products. Steelcase manufactures products for use around the world in every region. Products in two or more regions are "Global Products." The regional warranties (the Americas (including the United States, Canada, Mexico, the Caribbean, Central and South America), EMEA (Europe, except UK and Ireland, including Russian Federation, Middle East, Central Asia and Africa), United Kingdom and Ireland, and APAC (Asia Pacific) continue to apply for any product not included in the Global Products Warranty. Steelcase warrants that Global Products are free from defects in materials and workmanship. This warranty is valid from the date of delivery, regardless of shift usage, to the original End User and is non-transferable. Steelcase will repair or replace with comparable product, at its option and free of charge (for materials and components) any product, part or component which fails under normal use. If repair or replacement is not commercially practicable, Steelcase will provide a refund or credit for the affected product. End User means the final purchaser acquiring a product from

GLOBAL PRODUCTS - LIMITED WARRANTY

DESKS, TABLES, SCREENS, STORAGE AND

Steelcase: Bassline™, Bivi®, B-Free™, 4.8 Table, Fliptop Twin Table, Campfire® Big Lamp, Big Tables, Big Tables with trough and grommets, Paper Table, Personal Table, and Screens, c:scape®, Divisio Side Screen, FrameOne™/FrameOne Plus, High-Density Storage, Steelcase Flex, Flex Active Frames, Migration™, Migration™ SE, Ology™ Desk/Ology Bench, Verb™, Media:scape seating®, and Universal Storage.

Coalesse: CG_1™, Free Stand, Lagunitas™, Millbrae™, Montara650, Potrero415® ,Potrero415 Light, PowerPod, Sebastopol™, and SW_1®

Lifetime Warranty

Frame (except Coalesse), case/carcass, doors (except tambour), drawers (body and fronts), pulls/handles, supports, legs and base (except Coalesse), suspensions, carts, modesty panels, wire managers/cable trays, baskets, cup holder, dividers, rails, shelves, hanging folders bar, interlocks and locks

12 Year Warranty

Steelcase Flex, Migration, Migration SE, Ology Desk, and Ology Bench height-adjustable mechanisms and electronics, 4.8 Table, Fliptop Twin Table, Flex board clips, modular power/electrical power, mechanisms, casters, rollers, wheels and glides; Coalesse steel legs, and steel bases

5 Year Warranty

Tambour doors

3 Year Warranty

Coalesse/Steelcase electrical desktop, table top and rail mounted that houses power and/or data, and/or USB, Coalesse Free Stand mechanism and tablet, Coalesse SW1 table tablet including slide mechanism

SEATING

Steelcase: Amia™, B-Free, Buoy®, Brody™*, Campfire® Lounge, Ottoman and Wedge, cobī™, Gesture™, i2i™, Leap™, Node™, QiVi™, Reply™, Steelcase Flex, Steelcase Series®1, Steelcase Series®2, SILQ™, Shortcut®, Umami® and Think™
Coalesse: Enea™ Alto943, Hosu®, Lagunitas, LessThanFive™, Marien152, Massaud, Millbrae, Montara650, SW_1 and Visalia®

Lifetime Warranty

Frame (except Coalesse), seat shell, outerback, arm frame structure, base, stool

12 Year Warranty

Mechanisms, lumbar mechanisms, headrests, coat hanger, pneumatic cylinders/gas lifts, arm caps, foam, casters and glides, Node personal worksurface; Umami® frames, Coalesse lounge wood, bent-ply or steel frames

3 Year Warranty

Lagunitas articulating back, LessThanFive finish, SW_1 lounge tablet

*Brody electrical power is not covered in EMEA

SMART AND CONNECTED

media:scape®, ScapeSeries™

Lifetime Warranty

ScapeSeries and media:scape furniture components

1 Year Warranty

media:scape technology components

BOARDS AND EASELS

Steelcase Flex, Verb™

Lifetime Warranty

Verb whiteboards, docks, hooks, easels, storage caddy, and walltrack

12 Year Warranty

Verb teaching station lectern and plastic components

5 Years

Work Tents

3 Years Warranty

Flex markerboards, Flex Active Frames Mobile Board Clips

WORKTOOLS

SOTO™/1+1 Welcome Tools, Eyesite®/Plurio, CF/FSMA, Volley, and dash®

Lifetime Warranty

Mobile caddy, telephone caddy, binder holder, letter trays, launch pad non-powered and screen, functional screen, personal pocket; flat top hanger; wastebasket; footrest, mobile laptop support, laptop shelf, monitor bridge, ergo edge, and desk pad; cable clip, personal hook, toolbox, set of small

12 Year Warranty

Eyesite/Plurio, CF Series/FSMA, Volley, CPU supports and keyboard supports, lighting fixtures for dash

5 Year Warranty

Launch pad powered, lighting components for dash LED

3 Year Warranty

USB charging station, Eclipse Light

1 Year

Steelcase Flex Mobile Power

SURFACE MATERIALS

Refer to separate regional warranties for surface materials details.

Steelcase Warranty for Global Products

WARRANTY DOES NOT APPLY TO PRODUCT DEFECTS, DAMAGE, FAILURE OR LOSS RESULTING FROM:

- Normal wear and tear.
- Failure to apply, install, reconfigure, or maintain products according to published Steelcase or manufacturer instructions and guidelines.
- Abuse, misuse, or accident (including, without limitation, use of product in unsuitable environments or conditions).
- Alteration or modification of the product.
- The substitution of any unauthorized non-Steelcase components for use in the place of Steelcase components in an integrated product solution, including but not limited to worksurfaces, leg supports, panels, brackets, shelves, overhead bins and other integral components.

WARRANTY DOES NOT COVER:

- Products considered by Steelcase to be consumables; (e.g., batteries, bulbs/lamps).
- Other manufacturer's products, Steelcase shall pass along any warranty it receives with respect to other manufacturer's branded products.

• Pursuant to this limited warranty, if a product fails under ordinary use as a result of a defect in materials or workmanship, Steelcase will (i) repair or, at Steelcase's option, replace the affected product at no charge, with a new or refurbished product of comparable function, performance and quality or (ii) refund or credit of the purchase price for the affected product, at Steelcase's discretion, if

-- A product "defect" means an inadequacy in the materials or workmanship of the product that (i) existed at the date of delivery with respect to the product from Steelcase or a Steelcase Authorized Reseller to you and (ii) causes a failure of the product to perform under ordinary use in accordance with the materials and documentation accompanying the product.

-- An "ordinary use" means use of the product (i) in conformance with all applicable local, state, federal or national laws, codes and regulations (including without limitation building and/or electrical codes) and (ii) in accordance with manufacturer recommendations and/or instructions in the materials and documentation accompanying the product.

-- A "Steelcase Authorized Reseller" means any dealer that (i) is duly authorized by Steelcase to sell the product, (ii) is legally permitted to conduct business in the jurisdiction where the product is sold,

• Replacement parts are covered for 2 years or the balance of the original warranty, whichever is longer.

WARRANTY PROVIDES EXCLUSIVE REMEDIES:

In the European Union (EU), Steelcase participates in recycling networks for Waste Electronic and Electrical Equipment (WEEE) and pays for the associated administrative and recycling costs. EU-customers are responsible for collection and delivery of WEEE to the recycler identified by Steelcase, unless this responsibility is prohibited by national law.

WITHOUT PREJUDICE TO THE LEGAL WARRANTIES PROVIDED UNDER NATIONAL LAW, THIS LIMITED WARRANTY IS THE SOLE REMEDY FOR PRODUCT DEFECT AND NOT OTHER EXPRESS OR IMPLIED CONTRACTUAL WARRANTY IS PROVIDED, INCLUDING BUT NOT LIMITED TO ANY IMPLIED WARRANTIES OF MERCHANTABILITY OR FITNESS FOR A PARTICULAR PURPOSE. STEELCASE SHALL NOT BE LIABLE FOR ANY

Steelcase

©2021 Steelcase Inc. All rights reserved.
All specifications subject to change without notice.

STEELCASE WARRANTY

for Europe Middle East - Central Asia- Africa

(except UK /

YOU CAN DEPEND ON US. OUR PRODUCTS. OUR SERVICES. OUR PEOPLE.

Global Products are warranted in accordance with the Steelcase® Global Products Warranty. The list of Global Products are found in the Global Products Warranty. This Regional Warranty applies exclusively to products that are not Global Products. This warranty applies only to products delivered in Europe (except United Kingdom and Ireland) including Russian Federation, in Middle-East, in Central Asia and in Africa. Without prejudice to the legal warranties provided under national law, Steelcase Inc. ("Steelcase") warrants that Steelcase® and Coalesse® brand products are free from defects in materials or workmanship for a period of eight (8) years except as set forth below. The warranty is valid from the date of delivery to the original End User and is non-transferable. Steelcase will repair or replace with comparable product, at its option and free of charge (for materials and components) any product, part or component which fails under normal use. If repair or replacement is not commercially practicable, Steelcase will provide a refund or credit for the affected product. End User means the final purchaser acquiring a product from Steelcase or a Steelcase Authorized Reseller for the purchaser's own use and not for resale, remarketing or distribution. This

EXCEPTIONS

SYSTEMS, STORAGE, DESKS, TABLES AND BENCHING

5 years
All non-electrical mechanisms, foam
2 years
Electrical desk adjustments, markerboards, electronic locks

WORKTOOLS

2 years
Special products, electrical components, electronic components and lighting elements

SEATING

5 years
Chair gas lifts, Gesture™ and Leap™ 24/7 Chair with shifts use, foam
3 years
Gesture and Leap 24/7 Chair with Fame fabric in 3 shifts use

SURFACES

5 years
Textiles, decors and other coverings (excluding wood veneer)
3 years
Wood veneer, leather (excluding armrest covers), Coalesse glass, Fusion Coalesse surfaces, Coalesse SW_1® knit, Coalesse Elmosoft Leather, Silk fabric

IMAGE & MANAGEMENT

3 years
Image and Management products, except electrical components, electronic components and light elements
2 years
Image and Management electrical components, electronic components and light elements

STEELCASE WARRANTY for Europe Middle East - Central Asia- Africa

(except UK /

WARRANTY DOES NOT APPLY TO PRODUCT DEFECTS, DAMAGE, FAILURE OR LOSS RESULTING FROM:

- Normal wear and tear.
- Failure to apply, install, reconfigure, or maintain products according to published Steelcase or manufacturer instructions and guidelines.
- Abuse, misuse, or accident (including, without limitation, use of product in unsuitable environments or conditions).
- Alteration or modification of the product.
- The substitution of any unauthorized non-Steelcase components for use in the place of Steelcase components in an integrated product solution, including but not limited to worksurfaces, leg supports, panels, brackets, shelves, overhead bins and other integral components.
- Use in more than a single shift per day; in which case, the warranty is reduced accordingly (except for Gesture and Leap 24/7 chair see Exception section).

WARRANTY DOES NOT COVER:

- Products considered by Steelcase to be consumables (e.g., batteries, lamps, except projector lamps offer 6 months coverage).
- Armrest covers with leather are not covered.
- Variations occurring in surface materials (e.g., colourfastness, sheen on veneer surfaces or matching grains, textures and colors across dissimilar substrates and lots).
- Select Surfaces (fabric) and Customer's Own non-standard textiles and materials (COM) are not covered, except as warranted by the original supplier, for material properties including, but not limited to, quality, colourfastness, shade variations, puddling, wrinkling or abrasions.
- Other manufacturer's products (Steelcase will pass along any warranty it receives with respect to other manufacturer's branded products, including Officebricks and Viccarbe).

In the European Union (EU), Steelcase participates in recycling networks for Waste Electronic and Electrical Equipment (WEEE) and pays for the associated administrative and recycling costs. Our EU customers are responsible for collection and delivery of WEEE to the recycler identified by Steelcase, unless this responsibility is prohibited by national law.

Steelcase reserves the right to request that the damaged product be returned prior to granting a remedy.

The warranty is non-transferable and only applies to the first-time purchaser who purchased the product from Steelcase or a Steelcase Authorized Dealer for its own benefit and not for resale, remarketing or redistribution.

WITHOUT PREJUDICE TO THE LEGAL WARRANTIES PROVIDED UNDER NATIONAL LAW, THIS LIMITED WARRANTY IS THE SOLE REMEDY FOR PRODUCT DEFECT AND NO OTHER EXPRESS OR IMPLIED CONTRACTUAL WARRANTY IS PROVIDED, INCLUDING BUT NOT LIMITED TO ANY IMPLIED WARRANTIES OF MERCHANTABILITY OR FITNESS FOR A PARTICULAR PURPOSE. STEELCASE SHALL NOT BE LIABLE FOR ANY CONSEQUENTIAL, SPECIAL, PUNITIVE, OR INCIDENTAL DAMAGES.

WARRANTY PROVIDES EXCLUSIVE REMEDIES:

- Pursuant to this limited warranty, if a product fails under ordinary use as a result of a defect in materials or workmanship, Steelcase will (i) repair or, at Steelcase's option, replace the affected product at no charge, with a new or refurbished product of comparable function, performance and quality or (ii) refund or credit of the purchase price for the affected product, at Steelcase's discretion, if Steelcase determines that repair or replacement is not commercially practicable or cannot be timely made.

- A product "defect" means an inadequacy in the materials workmanship

of the product that (i) existed at the time when you received the product from Steelcase or a Steelcase Authorized Reseller and (ii) causes a failure of the product to perform under ordinary use in accordance with the materials and documentation accompanying the product.

- An "ordinary use" means use of the product (i) in conformance with all applicable local, state, federal or national laws, codes and regulations (including without limitation building and/or electrical codes) and (ii) in accordance with manufacturer recommendations and/or instructions in the materials and documentation accompanying the product.

- A "Steelcase Authorized Reseller" means any dealer that (i) is duly authorized by Steelcase to sell the product, (ii) is legally permitted to conduct business in the jurisdiction where the product is sold, and (iii) sells the product new and in its original packaging.

- A Consumer means any individual client who acts for its own use and for purposes that are outside its trade, business, craft or profession.

- Replacement parts are covered for 2 years or the balance of the original warranty, whichever is longer.

Steelcase

©2022 Steelcase Inc. All rights reserved.
All specifications subject to change without notice.

Warranty Statement

We make quality and modern workspaces available to more people. By focusing on meaningful innovations, proven solutions, and globally relevant design, we deliver products that stand the test of time. We are confident that our furniture will have the same value years from now as it was the first day you bought it. That's why the 10-year warranty is our promise not only to you but also to the environment, to minimize the negative impact of human activities by firstly reducing consumption.

This is our promise of longevity and sustainability.

10
year warranty

Terms of the warranty

- The warranty period starts from the date of sale of the Products to the Buyer.
- The warranty is valid only if a VAT invoice is provided. The Seller reserves the right not to prosecute warranty obligations if the Buyer has not provided the document mentioned above or if the document is incomplete or illegible.
- In order to be entitled to services under this warranty, a written notification regarding the damage must be submitted to Manufacturer immediately after it occurs.
- During the applicable warranty period, Manufacturer, at its option, will repair or replace any Product, part or component, covered by this warranty and sold after the effective date of it, considering Product fails under normal use as a result of defect in material or workmanship.
- For Product replacement, the same procedure as for the ordering of new Products is followed.
- Manufacturer reserves the right to request the return of damaged warranty Products before exchanging them.
- Extended Product use for more than 8 hours a day, 5 days a week will reduce the warranty period proportionally.
- Warranty repair execution can be carried out in the Buyer's, Sellers or Manufacturers premises, by Manufacturer, Seller or its authorized specialists. Assembly works and additional services are provided by the Seller.
- The non-warranty repair is carried out at the prices which are valid on the day when the Product's defect is declared.
- The warranty period includes the period during which the Buyer could not use the Product because of its defect.
- Warranty repairs do not represent the start of a new warranty period.
- The furniture covered with the natural wood veneer may not have the same wood structure and pattern. There might also be minor cracks or branch structures typical for natural wood. Over the time Product's coating shade might also change. This is not perceived as Product's quality defect or the deterioration of the quality.
- Manufacturer in no event shall be liable to any customer or any third party for any consequential, economic, indirect or incidental damages arising from the product defect, except cases where the consumer protection laws stipulate otherwise.
- Manufacturer is not responsible for damages which occurs to the Product in transit. Visible damages in transit shall be noted on the delivery note (CMR) in writing immediately after receipt of the Products and the Manufacturer shall be informed accordingly.

Non-standard furniture

- Non-standard furniture, which is made by unique, custom design or which has non-standard modifications, functions or other non-standard construction solutions, considering NARBUTAS standard furniture range at the time, 2 years warranty applies.

Exclusions

Limited warranty applies for these products and components:

- 5 years warranty for SILENT ROOM acoustic pods, height adjustment mechanisms for ACTIVE, EASY, JAZZ, MOTION, MOTION EXECUTIVE, MOVE&LEAD desks, drawers, sliding and tambour type doors, gas lifts, castors, glides, worksurfaces, foam parts, upholstery materials (fabric, textile).
- 2 years warranty for height adjustment mechanisms for B ACTIVE, ONE desks, furniture electronic components, leather coverings, concrete bases, foldable frames, adhesive and suspension fittings.

Warranty service is applicable only if the Product defects are identified before the end of the warranty period. In any case, the warranty is not valid and is not applicable:

- If the Buyer or a third party dismantled, irresponsibly transported Products, improperly assembled them, damaged or lost their parts.
- If the fault or defect in the Product is caused by nonconformity of furniture installation, care and exploitation instructions.
- If the Product was used or exposed to unsuitable environmental conditions (excessive humidity, exposure to chemicals or outdoor settings if not meant to be).
- If defect appears because the Buyer of the Products assembled or temporarily stored it in the premises where the construction or decoration works took place.
- If the breakdown or defect appeared because of force majeure or accidents.
- If the Buyer has not informed about the defects and breakdowns within a reasonable time after he noticed or should have noticed the defects.
- If the Product, part or component is considered to be consumable (e. g. light bulbs, batteries).
- For normal wear and tear (e.g., changes in surface finishes due to aging or exposure to UV light), pilling of textiles, wrinkles, scars or other distinguishing marks occurring naturally on leather.
- For glass breakage, mechanical damage and scratches of materials, the damage of Products, and losses occurring during the exploitation of Products due to improper usage or conduct, as well as the non-standard use or improper interference by the third parties (violations).
- For differences in the linearity of grain in melamine faced chipboard and laminates occurring within the same batch, matching of colors, grain or texture.

To the extent allowed by law, any implied warranties are disclaimed and, to the extent they are legally required, are limited in duration of this written warranty. This warranty does not exclude or restrict statutory rights which cannot be excluded by law.

Information updated August 2022